

# Coast in the Eye of the Storm

## Hurricane Katrina: August 29, 2005

Technical Report No. CMRC 06-1

March 2006



# Coast in the Eye of the Storm Hurricane Katrina: August 29, 2005



## Contributing Authors

**Thomas D. White, Ph.D., P.E.**

**Dennis D. Truax, Ph.D., P.E.**

**William H. McAnally, Ph.D., P.E., F. ASCE**

**Christopher D. Eamon, Ph.D., P.E.**

**Phillip M. Gullett, Ph.D., E.I.**

**Harry Cole, Ph.D., P.E.**

Department of Civil Engineering

Bagley College of Engineering

Mississippi State University

**Patrick Fitzpatrick, Ph.D.**

**Rita Jackson**

**Yee Lau**

**Yongzuo Li**

**Sachin Bhates**

GeoResources Institute

Mississippi State University

And

**Stephen V. Skalko, P.E.**

Portland Cement Association

## Photo on Cover

Aerial View of Concrete Home - Courtesy of FEMA

March 2006

Technical Report CMRC 06-1

### Abstract

A study was conducted that involved inspection of damage on the Mississippi Gulf Coast due to Hurricane Katrina. Observations were made of damage to buildings and infrastructure as well as materials used in their construction. These observations were documented photographically and catalogued.

Major storm characteristics were determined such as storm extent, wind speeds, and storm surge height. Associated tornadoes and other wind events were also addressed. Data was obtained from storm simulations, sensors, radar records and post Katrina engineering studies. Hurricane Katrina characteristics relative to other storms of record are compared.

A careful study was made of building codes, residential and commercial. Discussion is provided of building code evolution and current status. Particular interest was paid to the referenced standards providing design criteria for wind and flood loads. Some comparisons were possible of actual Hurricane Katrina winds and surge levels with those in the current guidance.

Degree of damage depended on type of material, construction (light or engineered) and if a structure was subject to wind or a combination of storm surge and wind. The study of Hurricane Katrina characteristics revealed the need for a hurricane classification format with an expanded scale for storm surge level. That modification (MSU Saffir-Simpson Scale) is proposed as being more effective in communicating to the public and responders storm surge danger for any particular hurricane event.

Review of existing and proposed building codes and design guides for both wind and flooding indicates utilization of land use planning and proposed building codes could mitigate future storm events. This includes hurricanes along the Gulf Coast and storms inland. Implementation of building codes infers trained staff for review, inspection and acceptance of projects. These functions should be supervised by an engineering department.

**Executive Summary**

With the next hurricane season imminent there is significant concern about safety of residents and fabric of the Gulf Coast economy and infrastructure. The coast is subject to storm surge and winds, sustained and gusting, as well as random wind events such as tornadoes, downbursts and mesovortices. Coastal and inland wind related damage to structures resulting from Hurricane Katrina varied from light to severe. However, damage from Katrina storm surge varied from superficial to total destruction.

Storms that form and strengthen in the Gulf of Mexico represent a threat to the region. The threat is significant to increasing shoreline development. Hurricane Katrina was a major hurricane having characteristics that made it particularly dangerous. An analysis was conducted that included simulation and study of sensors and recorded observations. Goals of the analysis were to understand better magnitudes of storm surge and wind and extent of areas affected. Application of results will be to improve land use planning and to understand applicability of proposed building codes.

Projected winds along the coast from Hurricane Katrina exceeded wind map contours in ASCE 7. Consequently, the adequacy of design wind speed contours along the coast should be reconsidered. Also, Mississippi is subjected to high winds from thunderstorms and tornados yearly. Statewide building code adoption and implementation with engineering certification and inspection may greatly mitigate such wind and storm damage.

The current Saffir-Simpson scale for hurricanes originating in the Atlantic Ocean was not effective in highlighting the storm surge magnitude experienced along the Mississippi and Louisiana Gulf Coast from Hurricane Katrina. As a result, a modification to the scale is recommended to clearly communicate to the public and responders potential storm surge magnitudes. Format of the MSU Saffir-Simpson scale is:

**MSU Saffir-Simpson Scale for Atlantic hurricanes.**

Category	Maximum sustained winds	Storm Surge (approximate)		
		feet		
	mph	a	b	c
1 (Minimal)	74-95		4-5	
2 (Moderate)	96-110		6-8	
3 (Extensive)	111-130		9-12	
4 (Extreme)	131-155		13-18	
5 (Catastrophic)	> 155		> 18	

The above is an abbreviated table to highlight addition of the three levels of storm surge,

## FINAL REVIEW

a, b and c. Current work is underway to add definition to the storm surge levels.

In general, engineer designed structures of reinforced concrete, structural steel, and timber performed well during the storm surge. This suggests existing design criteria and construction practices for these types of structures either included storm surge loading or include adequate capacity for this additional mode of loading. This issue has a degree of uncertainty.

US Highway 90 bridges spanning the Biloxi Back Bay and Bay St. Louis and several Casino parking garages with large horizontal surfaces were subject to transient uplift and side forces imposed by storm surge. In simply supported structures as these, the transients were of sufficient duration and magnitude to displace the simply supported components resulting in structural failure.

Reinforced concrete construction, formed-in-place or stay-in-place, exhibited reasonable performance when imposed loads are considered. However, most light-frame wood structures subjected to storm surge were destroyed and it appears failure initiated at fasteners. However, it is not known whether strengthened connections alone would decrease damage because the overall structural capacity of such structures when lateral storm surge load is considered is much less than that of typical engineered structures that survived.

**TABLE OF CONTENTS**

	Page
LIST OF TABLES	viii
LIST OF FIGURES	ix
CHAPTER 1 Introduction.....	1-1
CHAPTER 2 The Mississippi Gulf Coast and Storm Surge Potential.....	2-1
General.....	2-1
Gulf Coast Topography.....	2-1
Hurricane Damage Susceptibility.....	2-1
Winds.....	2-1
CHAPTER 3 Hurricane Katrina and Its Aftermath.....	3-1
General.....	3-1
Causes of Hurricane Destruction.....	3-6
Meteorological and storm surge characteristics of Katrina.....	3-15
I.    Katrina’s windfield.....	3-15
II.   Tornado activity and downbursts in Katrina.....	3-21
III.  Mesovortices in Katrina.....	3-25
IV.  Storm surge in Katrina.....	3-27
CHAPTER 4 Building Performance.....	4-1
General.....	4-1
Summary of Severe Structural Damage Observations.....	4-1
Infrastructure.....	4-2
Biloxi Bay Bridge.....	4-2
Bay St. Louis Bridge.....	4-2
Reinforced Concrete Structures.....	4-2
Precast Concrete Structures.....	4-3
Steel Frame Structures.....	4-3
Wood Structures.....	4-3
Facades and Non-Structural Walls.....	4-4
Stay In-Place (SIP) Reinforced-Concrete Construction.....	4-4
CHAPTER 5 Design Options.....	5-1
General.....	5-1
Design Options.....	5-1
Criteria Development.....	5-2

**FINAL REVIEW**

Page

CHAPTER 6 Building Code Review..... 6-1

    General.....6-1

    Codes and Standards.....6-1

    2003 International Building Code (IBC)..... 6-3

        General Loads.....6-3

        Wind Loads.....6-3

        Rain Loads.....6-3

        Flood Loads..... 6-4

        Resistance..... 6-4

        Roofs.....6-4

        Anchorage.....6-4

    2003 International Residential Code (IRC)..... 6-4

    2003 Florida Building (FBC) and Residential Codes (FRC)..... 6-4

    1999 BOCA National Building Code.....6-5

        Wind Loads.....6-5

    1999 Standard Building Code (SBC)..... 6-5

        General Loads.....6-5

        Wind Loads.....6-5

        Load Combinations.....6-6

    1997 Uniform Building Code (UBC)..... 6-6

        General Loads.....6-6

        Wind Loads.....6-7

    2002 ASCE 7..... 6-7

        Load Combinations.....6-8

        Wind Loads.....6-8

        Flood Loads..... 6-17

    2005 ASCE 24.....6-19

    Comparison of Code-Specified and Observed Loads..... 6-20

        Wind Gusts..... 6-20

        Storm Surge..... 6-21

CHAPTER 7 Conclusions and Recommendations.....7-1

    Conclusions..... 7-1

    Recommendations..... 7-2

LIST OF REFERENCES.....8-1

APPENDIX Selected Transcripts From Building Code Workshop.....A-1

    History of International Codes.....A-1

    Implications of International Building Code on Design and Construction.....A-15

**LIST OF TABLES**

Table	Page
3.1 Comparison of Hurricane Camille (1969) and Katrina (2005).....	3-3
3.2 The ten deadliest U.S. natural disasters.....	3-5
3.3 Destructive wind features in a hurricane.....	3-7
3.4 The Saffir-Simpson Scale for Atlantic hurricanes.....	3-13
3.5 Maximum observed sustained winds and wind gusts.....	3-16
3.6 Estimated maximum wind speeds and/or gusts (mph).....	3-20
3.7 Hurricane Katrina high water marks.....	3-34
3.8 Hurricane Katrina high water marks inland along bayous (USGS).....	3-36
6.1 Common Building Codes in US.....	6-1
6.2 Common Civil Engineering Design Standards.....	6-2
6.3 Wind Load Importance Factors in BOCA.....	6-5
6.4 Estimated and Measured Wind Gusts.....	6-21
6.5 Comparison of Design Flood Elevations and Katrina High Water Levels.....	6-22
7.1 MSU Saffir-Simpson Scale for Atlantic Hurricanes.....	7-3

LIST OF FIGURES

Figure	Page
2.1 Hancock, Harrison and Jackson Counties.....	2-2
2.2 Hancock County with + 10 ft (NAD 83 datum) contour highlighted in red.....	2-5
2.3 Hancock County with + 20 ft (NAD 83 datum) contour highlighted in red.....	2-5
2.4 Hancock County with + 30 ft (NAD 83 datum) contour highlighted in red.....	2-6
2.5 Hancock County with + 40 ft (NAD 83 datum) contour highlighted in red.....	2-6
2.6 Harrison County with + 10 ft (NAD 83 datum) contour highlighted in red.....	2-7
2.7 Harrison County with + 20 ft (NAD 83 datum) contour highlighted in red.....	2-7
2.8 Harrison County with + 30 ft (NAD 83 datum) contour highlighted in red.....	2-8
2.9 Harrison County with + 40 ft (NAD 83 datum) contour highlighted in red.....	2-8
2.10 Jackson County with + 10 ft (NAD 83 datum) contour highlighted in red.....	2-9
2.11 Jackson County with + 20 ft (NAD 83 datum) contour highlighted in red.....	2-9
2.12 Jackson County with + 30 ft (NAD 83 datum) contour highlighted in red.....	2-10
2.13 Jackson County with + 40 ft (NAD 83 datum) contour highlighted.....	2-10
3.1 NASA satellite image of Hurricane Katrina from Terra’s MODIS sensor on August 28, 2005, at 12:00 PM.....	3-2
3.2 Aerial photograph of the damage caused by a possible small tornado in Hurricane Andrew.....	3-8
3.3 Computer simulation depicting edge of hurricane eyewall breaking down into a series of mesoscale vortices.....	3-9
3.4 Radar-estimated 24-h rainfall totals (inches) for 8/29/05 and 8/30/05 from Hurricane Katrina.....	3-10
3.5 Airborne Doppler-derived radar wind speed cross-sections for August 28 and August 29 of Hurricane Katrina.....	3-14

## FINAL REVIEW

Figure	Page
3.6 Mobile WSR-88D single-Doppler radar in Mobile (KMOB WSR-88D) radial wind measurements.....	3-21
3.7 Mesocyclone signatures detected by the Mobile Doppler radar between 3:30AM to 12:45PM.....	3-23
3.8 Mesocyclone signatures detected by the Slidell Doppler radar between 3:30AM to 9:00AM.....	3-24
3.9 NASA satellite image from Terra’s MODIS sensor on August 28, 2005, at 12:00 PM.....	3-25
3.10 Time series plot of water elevations at the Paris Road, tide gauge, near Chalmette, LA from midnight August 25 to 8AM August 29.....	3-26
3.11 ADCIRC simulation of storm surge, valid 5AM.....	3-29
3.12 As in Figure 3.11, but 6AM .....	3-29
3.13 As in Figure 3.11, but 7AM .....	3-30
3.14 As in Figure 3.11, but 8AM .....	3-30
3.15 As in Figure 3.11, but 9AM .....	3-31
3.16 As in Figure 3.11, but 10AM .....	3-31
3.17 As in Figure 3.11, but 11AM .....	3-32
3.18 As in Figure 3.11, but 12AM .....	3-32
3.19 As in Figure 3.11, but 1PM .....	3-33
3.20 Bay St. Louis tide for August 29, 2005.....	3-38
3.21 Times series plot surge and wind from tide gauge in West Pascagoula, MS, at HWY 90, before equipment failure.....	3-39
3.22 As in Figure 3.21, but for Old Fort Bayou at Ocean Springs.....	3-40
3.23 As in Figure 3.21, but for Pearl River Entrance Light.....	3-41
3.24 As in Figure 3.21, but for Bayou Loutre, LA.....	3-42

**FINAL REVIEW**

Figure	Page
3.25 ADCIRC computer simulation time series of wind and storm surge for Bay St. Louis, MS, for hurricane-force wind conditions.....	3-43
3.26 As in Figure 3.25, but for Biloxi, MS.....	3-44
3.27 As in Figure 3.25, but for Ocean Springs, MS.....	3-45
3.28 As in Figure 3.25, but for Slidell, LA.....	3-46
4.1 Extent of Survey.....	4-5
4.2 Biloxi Bay Bridge.....	4-6
4.3 Biloxi Bay Bridge Bearings.....	4-6
4.4 Biloxi Bay Bridge Road Undermining.....	4-7
4.5 Pier Damage to Bay St. Louis Bridge.....	4-7
4.6 Bay St. Louis Bridge Bearings.....	4-8
4.7 Bay St. Louis Bridge Abutment Scour.....	4-8
4.8 Survived RC Structural Frame.....	4-9
4.9 Survived RC Structural Frame that Supported Wood Superstructure.....	4-9
4.10 Close-Up of RC Structural Frame in Fig 4.12.....	4-10
4.11 Survived RC Frame.....	4-10
4.12 Survived RC Frame and Exterior Wall Structure.....	4-11
4.13 Survived RC Frame Structure.....	4-11
4.14 RC Failed Columns.....	4-12
4.15 RC Frame Building Struck By Casio Boat.....	4-12
4.16 Failed PC Slabs Supported by RC Frame.....	4-13
4.17 Failed PC Girder System.....	4-13
4.18 Failed PC Column Connection.....	4-14

## FINAL REVIEW

Figure	Page
4.19 Failed PC Girder Connection.....	4-14
4.20 Failed PC Pedestrian Bridge.....	4-15
4.21 Failed PC Parking Structure.....	4-15
4.22 Failed PC Parking Structure.....	4-16
4.23 Survived Steel Frame.....	4-16
4.24 Survived Steel Frame.....	4-17
4.25 Survived Steel Frame.....	4-17
4.26 Survived Steel Frame.....	4-18
4.27 Survived Steel Frame.....	4-18
4.28 Survived Steel Frame.....	4-19
4.29 Survived Steel Frame.....	4-19
4.30 Failed Steel Frame.....	4-20
4.31 Failed Steel Frame with Open-Web Joist Roof.....	4-20
4.32 Typical Remains of Wood Structure.....	4-21
4.33 Roof Failure on Wood House.....	4-21
4.34 Roof Structural Failure on Wood Building.....	4-22
4.35 Siding Damage on Wood Building.....	4-22
4.36 Side-Sway Failure in Wood House.....	4-23
4.37 Survived Wood Pier System.....	4-23
4.38 Survived Wood Pier System.....	4-24
4.39 Survived Wood Doc.....	4-24
4.40 Survived Wood Glued-Laminated Structural Frame.....	4-25

**FINAL REVIEW**

Figure Page

4.41 SIP Wall Construction.....4-25

4.42 Survived SIP House with Wood Roof Damage.....4-26

4.43 Survived SIP House, Severely Damaged Wood House in Background.....4-26

4.44 Survived SIP Structure..... 4-27

4.45 Survived SIP Structure with Destroyed Wood Floor..... 4-27

6.1 Wind Speed Map (With permission from ASCE) .....6-10

6.2 Wind Speed Map (With permission from ASCE) .....6-11

6.3 Design Wind Pressures for Main Wind Resisting System (With permission from ASCE) .....6-12

6.4 Design Wind Pressures for Main Wind Force-Resisting System (With permission from ASCE) ..... 6-13

6.5 Wind Pressure Zones, Main Wind Force-Resisting System (With permission from ASCE) ..... 6-13

6.6 Height Adjustment Factor (With permission from ASCE)..... 6-14

6.7 Net Pressure for Components and Cladding Design (With permission from ASCE) .....6-15

6.8 Net Pressure for Components and Cladding Design (With permission from ASCE) .....6-16

6.9 Wind Load Areas for Components and Cladding Design (With permission from ASCE) .....6-17

6.10 Code (horizontal contours) and Simulated (vertical contours) Wind Gusts (MPH) ..... 6-21

**CHAPTER 1**

**INTRODUCTION**

Thomas D. White, PhD, P.E.  
Professor and Head  
Construction and Material Industries Chair

And

Dennis D. Truax, PhD, P.E., F. ASCE  
Professor  
Department of Civil Engineering  
Bagley College of Engineering  
Mississippi State University

As this report is being finalized, the next hurricane season starts in approximately four months. There are projects underway for repair, reconstruction and development of the Gulf Coast area. However, if such projects are not designed for potential hurricane effects they will be in jeopardy during the next and subsequent hurricane seasons.

In Mississippi, an important step was legislation allowing casinos to locate within 800 feet of the water's edge rather than on the water. Projects on the Gulf Coast such as casinos and other commercial development can be planned and engineered to account for potential storm surge and winds. However, residences and structures replaced or repaired without due consideration of potential storm surge and wind loads are in jeopardy and represent a serious, continuing liability.

It is important that factors controlling extent and severity of damage from hurricanes are known and actions taken to mitigate their effects. Consequently, the current study examines the Gulf Coast topography as well as uses simulation of Hurricane Katrina to characterize damaging factors. From an engineering perspective, observations were made of damage to structures and infrastructure and performance of materials used in construction. Subsequently, a study of building codes was undertaken to determine aspects that would best apply to both coastal and inland regions of Gulf Coast states affected by hurricanes.

Along the coast, storm surge and winds, both sustained and gusting, are a major concern. Heavy rains contribute to water damage when building envelopes are penetrated and increase the potential for damage from flooding. Random events such as tornadoes, downbursts and mesovortexes also occur along the coast and may adversely impact structures. Inland, sustained and gusting winds, heavy rains and tornadoes can extend for hundreds of miles. Much has been written and continues to be written about hurricane wind damage. Coastal and inland wind related damage to structures resulting from Hurricane Katrina varied from severe to light. On the other hand, storm surge

## **FINAL REVIEW**

was generally confined by elevation to be close to the shoreline, as should be expected. Storm surge damage of structures resulting from Katrina varies from total destruction to superficial damage.

Wind damage in Florida from Hurricane Andrew, August 24, 1992 resulted in revisions to strengthen the South Florida Building Code. A number of organizations have continued to work on building codes and there has been consolidation and further refinement. A study was made of building codes as well as assessment of appropriateness.

An overall evaluation is made of results of the study with conclusions and recommendations as to range in hurricane characteristics, structure and infrastructure damage and building code application.

### **Acknowledgements**

Funding for this project was provided by the RMC Research Foundation and the Mississippi Concrete Industries Association. The Mississippi Department of Transportation enabled the project team's access to US-90 early in recovery operations. Preparation of the report was a team effort. Significant contributions were made by Dr. William McAnally, Dr. Christopher Eamon and Dr. Philip Gullett, Civil Engineering Department, Mississippi State University. Other Civil Engineering faculty involved were Dr. Dennis Truax, Dr. Harry Cole and Dr. Li Zhang. Significant contributions were made by Dr. Pat Fitzpatrick, Yee Lau, Sachin Bhate and Yongzuo Li of the GeoResources Institute (GRI), Mississippi State University.

**CHAPTER 2**

**THE MISSISSIPPI GULF COAST AND STORM SURGE POTENTIAL**

William H. McAnally, PhD, P.E. F.ASCE  
Associate Professor  
Department of Civil Engineering  
Bagley College of Engineering  
Mississippi State University,

Patrick Fitzpatrick, PhD  
Associate Research Professor

and

Rita Jackson  
Extension Associate  
GeoResources Institute  
Mississippi State University

**General**

Geographic characteristics of the Caribbean and Gulf of Mexico and adjoining land masses; currents and warm waters of these regions and seasonal atmospheric conditions contribute to storm development and strengthening. At the same time Northern and Western coasts of the Gulf are susceptible to storm surge and wave action. The Mississippi Gulf coast has been attractive and will continue to be attractive for economic development. Hurricane Katrina tested past land use practices and established the baseline for future land use practices. These practices will be affected largely by the height of potential storm surge and the extent of area affected.

**Gulf Coast Topography**

The Mississippi Gulf Coast comprised of Hancock, Harrison, and Jackson Counties, is characterized by a shallow, gently sloping offshore bathymetry and low relief on-shore topography. Figure 2.1 shows the three counties, topographic contours, cities, major transportation routes, and streams as documented in the Mississippi Automated Resource Information System (MARIS, 2005).

**Hurricane Damage Susceptibility**

Hurricane damage is caused by winds, storm surge, waves, and flooding from rainfall. The Mississippi Gulf Coast offshore bathymetry and onshore topography make it susceptible to severe damage from these causes.

**Winds**

Straight line winds are characterized by their average, or sustained speed, and maximum speed in gusts. As hurricanes make landfall, interactions with thunderstorms form tornadoes, which are prolific in the right front quadrant of the storm. Hurricane tornadoes tend to cluster near the hurricane core (within 100 km), and in the outer rainbands about 300 km from the center.



Figure 2.1 Hancock, Harrison and Jackson Counties

## FINAL REVIEW

Also accompanying the thunderstorms are areas where heavy rainfall accelerates air to the ground, known as downbursts, and spreads out at speeds greater than 100 mph. In addition, another phenomenon called *mesoscale vortices*, whirling tornado-like winds can form at the boundary of the eyewall, with winds up to 200 mph.

The expected level of damage for a given hurricane intensity is described by the *Saffir-Simpson Hurricane Scale* (shown in Chapter 3, Table 3.4). It was devised in 1971 by Herbert Saffir, an engineer in Miami, for the World Meteorological Organization. Robert Simpson, the director of the National Hurricane Center, then added the storm surge portion. This scale classifies hurricanes into five categories according to central pressure, maximum sustained winds, storm surge, and expected damage. Although all categories are dangerous, categories 3, 4, and 5 are considered *major hurricanes*, with the potential for widespread devastation and loss of life. Whereas only 21 percent of U.S. land-falling tropical systems are major hurricanes, they historically account for 83 percent of the damage. Note that the scale is not linear. A Category 3 hurricane causes 50 times as much damage as a Category 1, and a Category 4 is 250 times more destructive than a Category 1.

### Storm Surge

Although wind and precipitation flooding are obviously dangerous, historically most people have been killed in the *storm surge*, the rise of the sea along the shore generated by an intense storm such as a hurricane. The storm surge is caused primarily by the winds pushing water toward the coast and wave breaking, which propels water further inland. A secondary contribution to surge is made by the reduced barometric pressure within the storm, which raises a dome of water higher than the surrounding ocean even in the absence of winds. However, wind and wind-generated waves are the primary contributors to storm surge. A surge rises gradually at first, then increases quickly as the storm makes landfall. Storm surge does not occur as a wall of onrushing water like the Indonesian tsunami; however, large wind-generated waves moving on top of the surging waters may create the impression of a tsunami-like effect, and the force of those waves may be responsible for great damage. For a hurricane, the surge typically lasts several hours and affects about 100 miles of coastline. Storm surge elevations typically vary from 5 to 25 feet depending on a variety of hurricane conditions.

Simulations of Hurricane Katrina shown in Chapter 3 indicate maximum surges in Mississippi of 28 to 31 ft. Observed high water marks depict a similar picture as the storm surge simulations and are presented in Chapter 3. Surge values of 28 to 31 feet have been documented between Pearlinton and Bay St. Louis, MS. High water marks between 20 and 27 feet occurred between Bay St. Louis and Biloxi. Ocean Springs, Pascagoula, and coastal Alabama experienced smaller but still significant surge of 12-19 feet. In particular, eastern Mississippi had not experienced such surge levels in many decades. Florida and eastern Alabama experienced surge values on the order of 5 feet.

**Potential Surge Inundation Levels**

In order to illustrate the potential for hurricane surge in coastal Mississippi, Figures 2.2 through 2.13 display the areas that would be submerged by uniform 10 ft, 20 ft, 30 ft, and 40 ft surges. Note that such surges occurring across such a wide area in the same storm are unlikely; however, these maps help illustrate the extent of such surges, were they to occur under a variety of hurricane sizes and tracks. Map data are from the Mississippi Automated Resource Information System (MARIS, 2005).

The maps show that a large extent of the three coastal Mississippi counties are subject to inundation from a surge equivalent to that of Hurricane Katrina and even smaller storms can inundate significant areas.

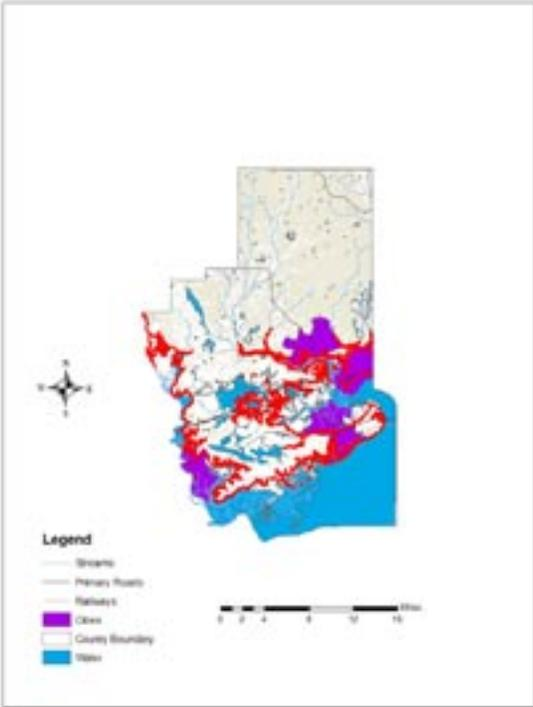

Figure 2.2 Hancock County with + 10 ft (NAD 83 datum) contour highlighted in red.

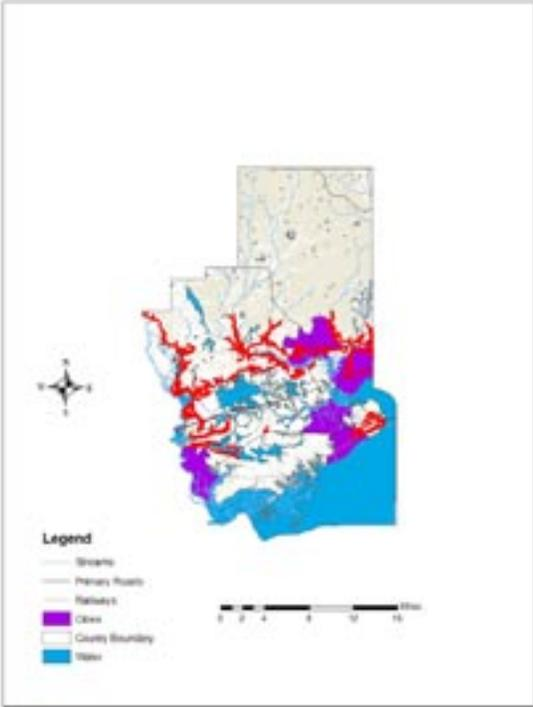

Figure 2.3 Hancock County with + 20 ft (NAD 83 datum) contour highlighted in red.

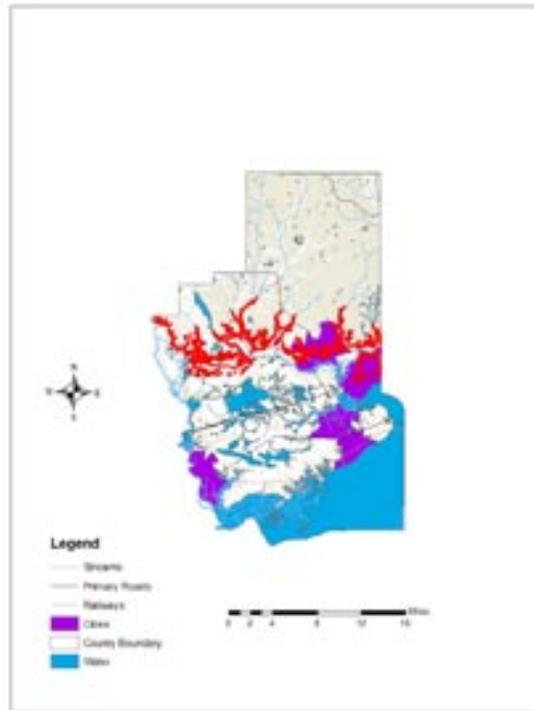

Figure 2.4 Hancock County with + 30 ft (NAD 83 datum) contour highlighted in red.

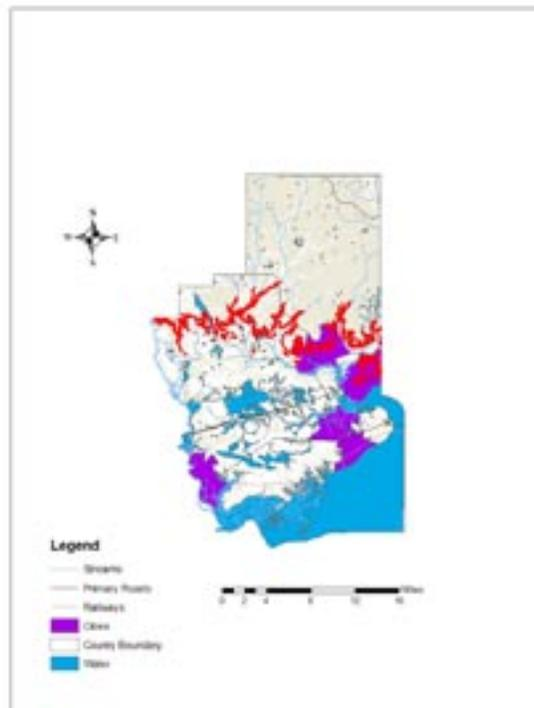

Figure 2.5 Hancock County with + 40 ft (NAD 83 datum) contour highlighted in red.

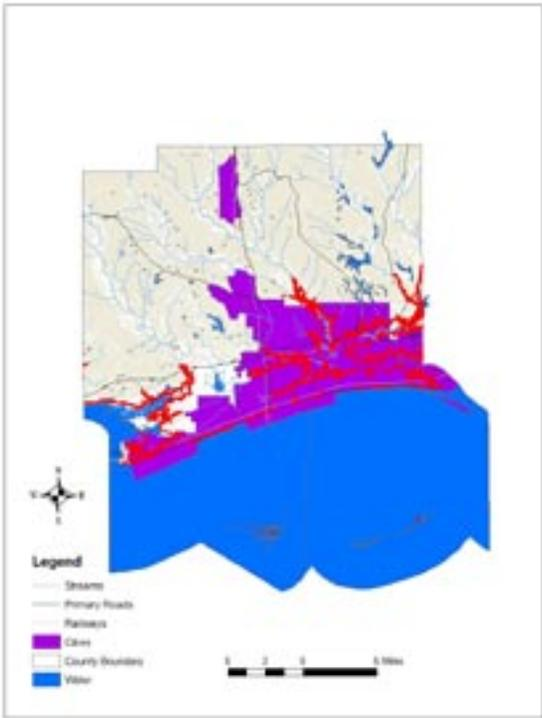

Figure 2.6 Harrison County with + 10 ft (NAD 83 datum) contour highlighted in red.

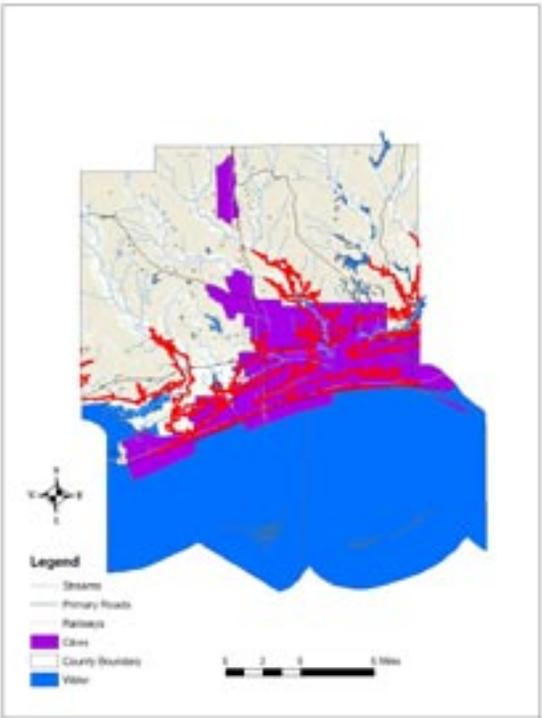

Figure 2.7 Harrison County with + 20 ft (NAD 83 datum) contour highlighted in red.

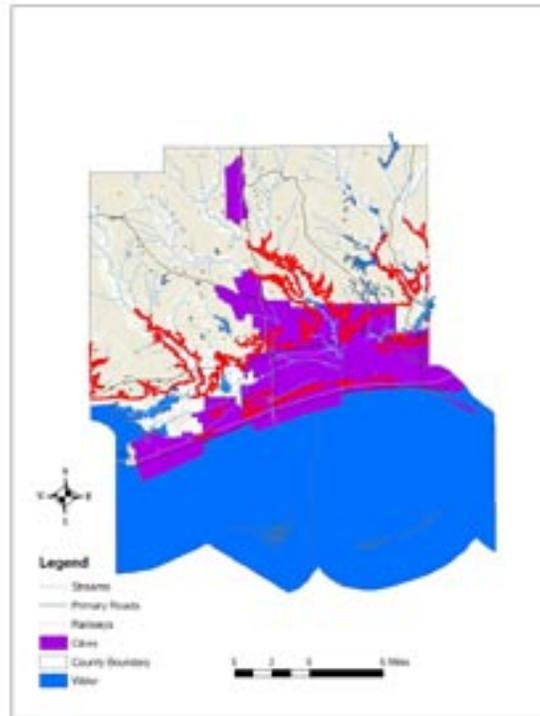

Figure 2.8 Harrison County with + 30 ft (NAD 83 datum) contour highlighted in red.

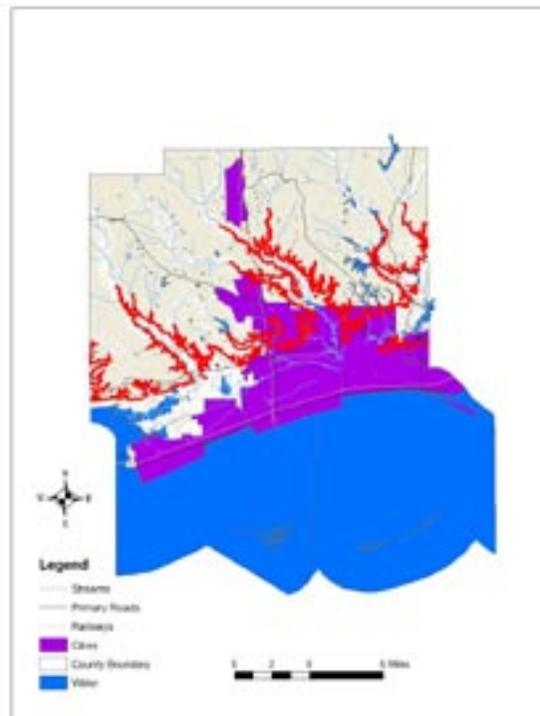

Figure 2.9 Harrison County with + 40 ft (NAD 83 datum) contour highlighted in red.

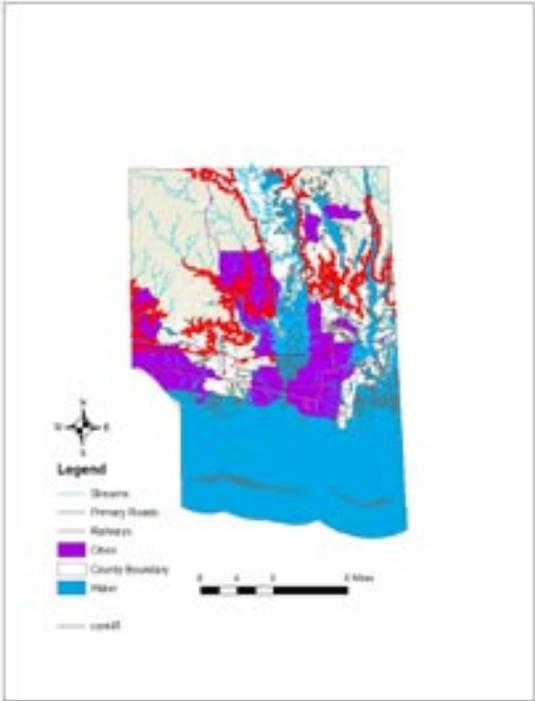

Figure 2.10 Jackson County with + 10 ft (NAD 83 datum) contour highlighted in red.

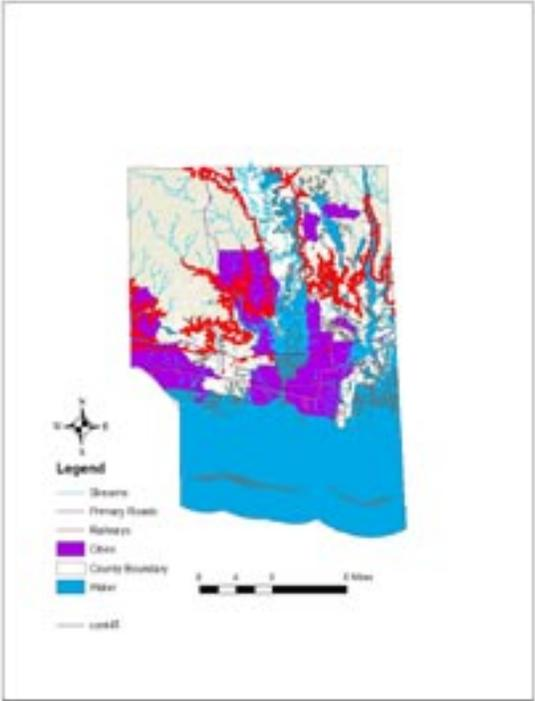

Figure 2.11 Jackson County with + 20 ft (NAD 83 datum) contour highlighted in red.

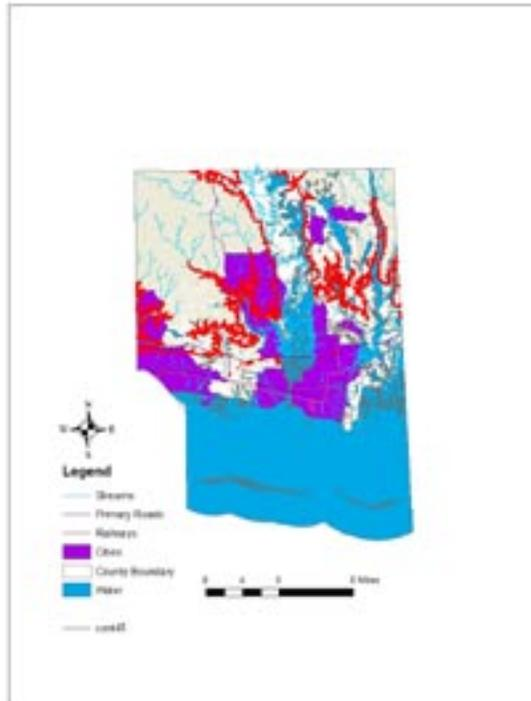

Figure 2.12 Jackson County with + 30 ft (NAD 83 datum) contour highlighted in red.

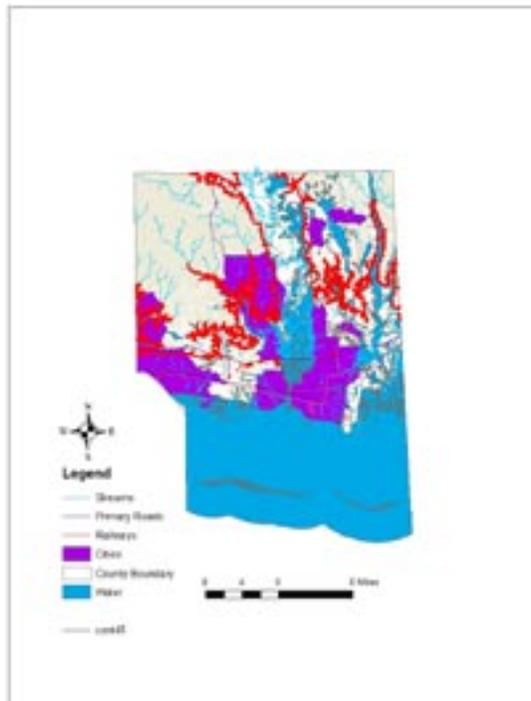

Figure 2.13 Jackson County with + 40 ft (NAD 83 datum) contour highlighted in red.

**CHAPTER 3**

**HURRICANE KATRINA AND ITS AFTERMATH**

Patrick Fitzpatrick, Ph.D.  
Associate Research Professor,

Yee Lau  
Research Associate II

Yongzuo Li  
Research Associate II

And

Sachin Bhates  
Research Associate II  
GeoResources Institute  
Mississippi State University

**General**

Hurricane Katrina is among the worst natural disasters in U.S. history in terms of geographical coverage and accompanying fatalities. Katrina first made landfall in south Florida on August 25, 2005, as a Category 1 hurricane. Landfall occurred between Hallandale Beach and North Miami Beach, Florida, with wind speeds of approximately 80 mph and gusts to 90 mph. As the storm moved southwest across the tip of the Florida peninsula, Katrina's winds decreased slightly before entering the Gulf of Mexico. The storm caused moderate property damage in Florida and claimed 12 lives. Given that Katrina spent only seven hours over land, its strength was not significantly diminished and quickly re-intensified regaining strength shortly after moving over the warm waters of the Gulf of Mexico.

Atmospheric and ocean conditions were conducive to rapid intensification, which lead to Katrina attaining major hurricane (Category 3) status on the afternoon of August 26th. This intensification was also accompanied by an unusual expansion outwards of hurricane-force winds, transforming the storm into a large hurricane typically only seen in the Pacific Ocean. Katrina continued to strengthen and moved northwards during the next 48 hours, Katrina reached maximum wind speeds on the morning of Sunday August 28th of 172 mph (Category 5), and its minimum central pressure dropped that afternoon to 902 mb - the 6th lowest on record for an Atlantic storm (Figure 3.1).

Although Katrina was comparable to Hurricane Camille (1969), it was a significantly larger storm (Table 3.1). Katrina's hurricane-force winds extended 120 miles from

## FINAL REVIEW

the storm center, and tropical storm-force winds extended 230 miles. Katrina also maintained a large eye, thereby providing a large areal-coverage of its highest winds. Finally, Katrina moved slower than Camille, thereby increasing storm surge potential and time of wind exposure. All these conditions resulted in catastrophic destruction and fatalities, which dwarf the previous benchmark hurricanes of Camille and Betsy (1965) in southeast Louisiana, Mississippi, and Alabama.



Figure 3.1. NASA satellite image of Hurricane Katrina from Terra's MODIS sensor on August 28, 2005, at 12:00 PM. (Hurricane Katrina was about 200 miles from southeast Louisiana at this time as a Category 5 hurricane.)

Katrina made landfall at 6:10AM on the morning of August 29 in Buras, LA, as a major hurricane with a central pressure of 923 mb - the 4<sup>th</sup> lowest on record for a US landfalling Atlantic storm. The size of the hurricane caused a record storm surge in southeast Louisiana, coastal Mississippi, and coastal Alabama. A wide swath of wind damage extended over 125 miles inland in some regions. Extensive structural damage is described elsewhere in this report. The intensity and storm surge water levels are currently the

## FINAL REVIEW

subject of some debate. A range of intensities is presented in Table 3.1. This chapter presents information on the storm intensity and surge.

Table 3.1. Comparison of Hurricane Camille (1969) and Katrina (2005).

Measure	Camille	Katrina
Intensity (sustained winds and pressure)	Estimated 190 mph 909 mb (26.84 in. mercury)	125-135 mph in Buras, LA landfall 120-125 mph at MS landfall 918 mb (27.11 in. mercury) in Buras landfall 927 mb (27.37 in. mercury) in MS landfall
Eye size	11 miles	35 miles
Distance hurricane-force winds from storm center	60 miles	120 miles
Distance tropical storm-force winds from center	180 miles	230 miles
Translation speed	18 mph	15 mph
Fatalities	172 in Mississippi 9 in Louisiana 114 in Virginia 2 in West Virginia	238 in Mississippi, trending to 275 1293 in Louisiana, trending to 1650 14 in south Florida 2 in Georgia 2 in Alabama
Maximum storm surge	25 feet in Pass Christian, 10-20 feet to Pascagoula 15-25 feet in east Louisiana marsh	35 feet possible in Waveland and Bay St. Louis, 20-25 along MS coast 20-30 feet in Pearl River area, east LA marsh, northshore of Lake Pontchartrain 15 feet southshore of Lake Pontchartrain

This chapter primarily focuses on Hurricane Katrina's impact on Mississippi. However, New Orleans, which is below sea level in most areas, is protected by a series of levee systems designed for a fast moving Category 3 hurricane. Because of the elevation deficit, rainfall has to be pumped out of the area. Katrina's storm surge overwhelmed levees east of the city and Lake Pontchartrain's north shore, inundating the first floor of all structures in St. Bernard Parish. Similarly, the region known as New Orleans East experienced almost total flooding. Inside Slidell's levee system and along Lake Pontchartrain's north shore and accompanying river systems, the surge penetrated

## FINAL REVIEW

miles inland, causing extensive flooding. Outside the levee systems in coastal regions bordering Lake Pontchartrain, as well as the marsh towns east and south of New Orleans, devastation was total, leaving little but concrete slabs and debris throughout the marine and estuarine zone.

In New Orleans itself and its western suburbs, breaches in the 17<sup>th</sup> Street Canal and London Avenue Canal caused flooding over eighty percent of the city. The suburbs to the west also experience flooding, since pump operators were evacuated and then unable to return. Because the pumps were not operating, rainfall collected and as well, the storm surge entered through the sluice gates of the non-functioning pumps.

Although most New Orleanians and surrounding residents evacuated ahead of the storm, tens of thousands were stranded in the city. There were some 20,000 refugees in the Superdome sports facility, 20,000 in the city's convention center and many more trapped in their homes.

Damage occurred in an area greater than the size of Britain. The national recovery effort is expected to cost billions, obliterating the previous record damage of \$26.5 billion caused by Hurricane Andrew (1992). In Mississippi, about 68,000 homes were destroyed, and another 65,000 suffer major damage. In Louisiana, about 250,000 homes were damaged or destroyed. It is the largest permanent displacement of people in history. Homeless were sheltered in a variety of ways, including cruise ships, hotels, FEMA trailers, and housing across the nation.

Total deaths were between 1300 and 1400, with between 200 and 250 deaths in Mississippi. That places it third in terms of hurricane fatalities behind the Lake Okeechobee Hurricane (1928) and the Galveston Hurricane (1900) in the past century, and the sixth deadliest natural disaster in U.S. history (Table 3.2). In Mississippi, the number of fatalities exceeded Camille's (Table 3.1).

## FINAL REVIEW

Table 3.2. The ten deadliest U.S. natural disasters.

Rank	Year	Event	Deaths
1	1900	Galveston Hurricane	8000-12,000
2	1928	Lake Okeechobee Hurricane	2500-3000
3	1889	Johnston ood	2200
4	1893	“Sea Islands” Hurricane (Georgia/S. Carolina)	2000-2500
5	1893	“Cheniere Caminda” Hurricane (Louisiana)	2000
6	2005	Katrina	1900-2000
7	1881	Hurricane #5 (Georgia/S. Carolina)	700
7	1906	San Francisco earthquake	700
9	1925	Tri-State Tornado	695
10	1938	New England Hurricane	600-720

Katrina’s economic impact is enormous. In southeast Louisiana, the agriculture, oil, fishing, and tourism industries are decimated, and commerce in New Orleans will be affected for years. Refinery shutdowns and damage to oil and natural gas facilities from Katrina (and later by Hurricane Rita) severely disrupted energy supplies, causing large price spikes. As of December 2005, about 20-30% of the oil and gas wells were inoperative because of damage to offshore platforms, underwater pipelines, and refineries. Mississippi’s tourist, agriculture, timber, and poultry industries also suffered immense losses. Mississippi’s thriving water-bound casino industry, which generates \$500,000 a day in tax revenue, was heavily impacted, prompting legislation allowing land-based locations. Fortunately, a temporary spike in sales tax revenue due to rebuilding and relief spending has helped compensate for taxes from casino operations. Katrina also sets another precedent. Hurricane storm surge fatalities have not been a major issue in the U.S. since Hurricane Camille in 1969. This catastrophe will focus renewed efforts on evacuation, mitigation, and public education issues.

This report presents basic information about Katrina’s wind and storm surge elements.

### Causes of Hurricane Destruction

Coastal communities devastated by strong hurricanes usually take years to recover. Many forces of nature contribute to the destruction. Obviously, hurricane winds are a source of structural damage as discussed elsewhere in this report. Debris is also propelled by strong winds, compounding the damage. Other concerns include downed trees and power poles, causing power outages sometimes for extended periods of time.

It is important to note that hurricane intensity is defined by *sustained winds*, not

## FINAL REVIEW

instantaneous winds. Sustained winds are the average speed over a period of time at 33 feet above the ground. For Atlantic based storms, this averaging is performed over a 1-minute period. The actual wind will be faster or slower than the sustained wind at any instantaneous period of time. For example, a hurricane with maximum sustained winds of 90 mph may contain gusts of 100 mph or more. Also, hurricane categories are defined by maximum winds somewhere in the storm, almost always near the center, and that winds may be slower in other parts of the storm. For example, maximum sustained winds of 90 mph may only be concentrated in the northeast section near the hurricane center, with the southwest quadrant containing weaker winds.

To standardize intensity measurements worldwide, not only is time-averaging required, but a measurement elevation needs to be defined. The World Meteorological Organization states that official hurricane wind specifications are at a 10-meter (33-foot) height. Since winds are rarely measured at this level, mathematical assumptions are required to normalize wind measurements to this height.

Isolated pockets of enhanced winds also occur in hurricanes. Accompanying the steady winds will be wind gusts up to several seconds duration that can amplify or initiate destruction. More powerful wind entities also occur in isolated regions. Features associated with wind enhancement are outlined in Table 3.3.

As hurricanes make landfall, interactions with thunderstorms form columns of rapidly rotating air in contact with the ground. These events are known as *tornadoes*. Tornadoes are especially prolific in the right front quadrant at landfall. Hurricane related tornadoes tend to cluster near the hurricane core (within 100 km) and in the outer rainbands about 300 km from the center. Hurricane related tornadoes tend to be relatively weak with winds less than 157 mph and to have short tracks and brief touchdowns. On the day of landfall, tornadoes occur close to the center with proportionally fewer tornadoes in the outer rainbands. However, on the days following landfall, tornado occurrences show an increasing preference for the outer rainbands. Tornadoes in outer bands peak in the early afternoon due to a maximum solar heating, while inner-core tornadoes show no diurnal peaks. Large hurricanes produce more tornadoes than small hurricanes. Tornado frequency also increases in the more intense hurricanes. Finally, hurricanes with a slow or fast translation speed produce few tornadoes, while hurricanes with a motion between 8 and 33 mph produce tornadoes. Based on these composite studies, Katrina was a good candidate for tornado activity. An example of tornado destruction in Hurricane Andrew is shown in Figure 3.2.

**FINAL REVIEW**

Table 3.3. Destructive wind features in a hurricane.

Sustained wind	The average wind speed over a period of time at 33 feet above ground level. In the Atlantic this averaging is performed over a 1-minute period.
Wind gust	A sudden, brief increase in speed of the wind. Gusts are reported when the peak wind speed reaches at least 18 mph and the variation in wind speed between the peaks and lulls is at least 10 mph. The duration of a gust is usually less than 20 seconds. Wind gusts are 1.25 larger than the sustained wind over the ocean, 1.35 times larger over vegetation, and 1.65 times larger over woods and cities.
Downburst	A strong downdraft that exits in the base of a thunderstorm and spreads out at the earth’s surface as strong and gusty horizontal winds that can cause property damage.
Tornado	A rapidly rotating column of air that protrudes from a cumulonimbus cloud in contact with the ground, often (but not always) visible in the shape of a funnel or a rope. The right front quadrant of a hurricane often produces many tornadoes at landfall due to ground friction, but they can appear in any hurricane squall line.
Mesovortex	Whirling vortices that form at the boundary of the eyewall and eye where there is a tremendous change in wind speed. Winds may be up to 200 mph, especially in areas where winds are in the same direction as the eyewall winds, and therefore extremely destructive. Five to ten times wider than a tornado, perhaps even larger in some cases. Some studies suggest they have a ratio 1/10th the diameter of the hurricane eye. They are believed to occur in major hurricanes (Category 3 or more). Also called mesoscale vortices.

*Mesoscale vortices*, or sometimes *mesovortices*, were documented in Hurricane Hugo (1989) and Hurricane Andrew (1992). These whirling winds are illustrated in Figures 3.3 and 3.4. Updrafts in the eyewall can stretch the vortices vertically, making them spin faster with winds up to 200 mph. An instrument which measures the vertical distribution of winds in hurricanes, called a dropsonde, was deployed in Hurricane Isabel (2003) and fell through a mesovortex, measuring winds of 241 mph.



Figure 3.2. Aerial photograph of the damage caused by a possible small tornado in Hurricane Andrew (moving toward the west in the small gray area labeled C, black dashed line highlights the path of the tornado.)

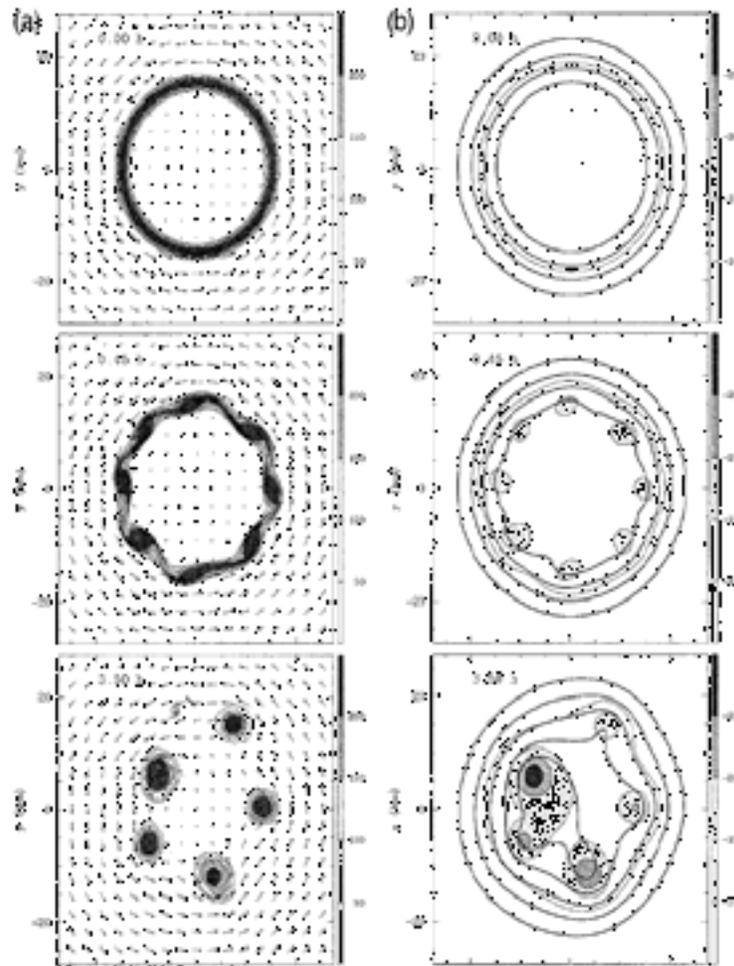

Figure 3.3. Computer simulation depicting edge of hurricane eyewall breaking down into a series of mesoscale vortices.

Flooding produced by hurricane rainfall can also be destructive and was the leading cause of hurricane-related fatalities in the U.S. in the period between Hurricanes Camille and Katrina. A majority (57 percent) of the 600 U.S. deaths between 1970 and 1999 due to hurricanes or their remnants was associated with inland flooding. Fortunately, fatalities from inland flooding due to precipitation did not occur in Katrina. Forty-eight hour rainfall amounts between August 29 and 31 averaged between 3 and 7 inches throughout Louisiana and Mississippi. Rainfall amounts were greatest along and just west of the center. A large swath of 8-10 inches of rain fell cross southeastern Louisiana and southwestern Mississippi, with a small area of 10-12 inches between Covington, LA, and Gulfport, MS and Poplarville, MS.

# FINAL REVIEW

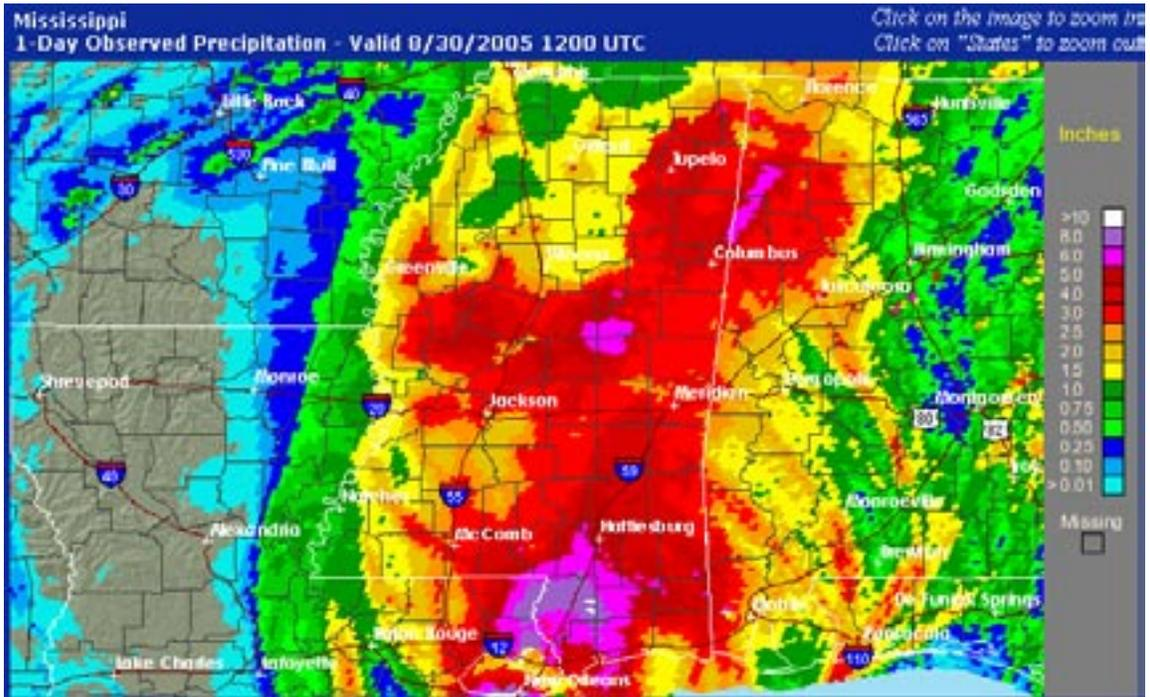
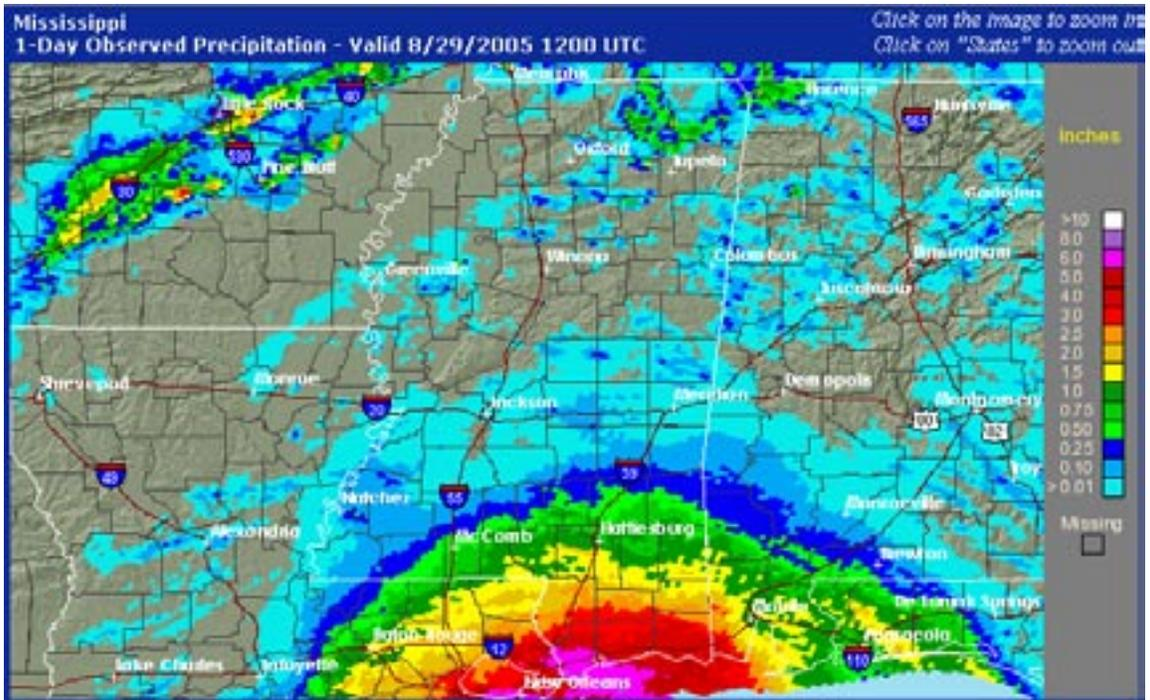

Figure 3.4. Radar-estimated 24-h rainfall totals (inches) for 8/29/05 (top) and 8/30/05 (bottom) from Hurricane Katrina.

## FINAL REVIEW

Although wind and flooding from rainfall are obviously dangerous, historically most fatalities result from hurricane *storm surge*, defined as an abnormal rise of the sea along the shore generated by an intense storm such as a hurricane. The storm surge is caused primarily by winds pushing water toward the coast and wave breaking, which propels water further inland. A secondary contribution to surge is from the reduced barometric pressure within the storm, which causes a dome of water higher than the surrounding ocean. However, wind and wind-generated waves are the primary contributors to storm surge. The surge rises gradually at first, then more rapidly as the storm makes landfall. Storm surge does not occur as a tidal wave, as depicted in at least one Hollywood movie. However, large wind-generated waves moving on top of the surging waters may create the impression of a tsunami-like effect, and the force of those waves may be responsible for great damage. For a hurricane, the surge typically lasts several hours and affects about 100 miles of coastline. Storm surge elevations typically vary from 5 to 25 feet depending on a variety of hurricane conditions.

Factors which impact storm surge elevation include:

- *Storm size*: The larger the areal extent of tropical storm-force winds, the higher the water elevation
- *Storm central pressure*: Lower interior atmospheric pressure increases the water level. Water expands as pressure decreases, known as the *inverse barometer effect*. For every 10-mb pressure drop, water expands 3.9 inches.
- *Storm intensity*: The maximum wind speed is the most important factor. The more intense the hurricane, the higher the water elevation.
- *Bathymetry*: As the surface currents driven by the wind reach shallow coastlines, bottom friction impedes the seaward return flow near the bottom, causing water to pile up. Shallow areas with a gradual slope will experience greater storm surges than areas with a shelf that drops off rapidly near the coast. Because of Mississippi's shallow coastal waters, the state is prone to high storm surges.
- *Speed of the system*: Because a slow moving hurricane has a longer time to transport water onshore, slow moving systems are associated with higher storm surge. Slower moving hurricanes can cause a storm surge 50-70% higher than fast moving hurricanes. Fast moving hurricanes cause the surge to "spike" over a few hours with an overall lower surge.
- *Wave setup*: Water levels can increase from onshore waves in windy conditions. Under normal conditions, waves that reach the coast break and water flows back out to the sea under the next incoming wave. The super-elevation required to drive the under flow is called wave setup and occurs whenever waves are breaking on the shoreline. In hurricane conditions, this setup can be quite large and is most pronounced when the bottom slope is steep, because in shallow water waves break farther offshore. However, wind-induced surge enables waves to penetrate much further inland before they break.
- *Track angle*: Storms which make landfall perpendicular to the coastline produce larger storm surges than those which hit at an angle. Storms which make landfall at an angle have a smaller surge because some transported water experiences reflection and cross-current transport.

## FINAL REVIEW

The storm surge is always highest on the side of the eye corresponding to onshore winds, which is usually the right side of the point of landfall. Winds are also fastest in the right front quadrant because storm motion (which averages about 10 mph but varies substantially) is added to the hurricane's winds. Because winds spiral inward, the storm surge is greatest along the eyewall.

The total elevated water includes three additional components - the astronomical tide, the steric effect, and ocean waves. The astronomical tide results from gravitational interactions between the earth and the moon and sun, generally producing two high and two low oceanic tides per day in most U.S. locations, but only one high and one low tide per day in Mississippi. Should the storm surge coincide with the high astronomical tide, the additional elevation will be added to the water level. Waves are another important contributor to water level. In addition to contribution of wave setup to the surge, large waves can be expected on top of the surge. The final contributor is water temperature. Because warm water expands, water levels are naturally highest in the summer, known as the *steric effect*.

Water in motion imposes large dynamic pressures. Structures of light construction will be demolished when struck by the storm surge and associated waves. Ocean currents set up by the surge, combined with the waves, can severely erode beaches, islands, and highways. People caught in a storm surge may be killed by injuries sustained during structural collapse or by drowning. Death tolls for unevacuated coastal regions can be significant. The worst natural disaster in U.S. history occurred in 1900 when a hurricane-related 8 to 15-foot storm surge inundated the island city of Galveston, Texas, and claimed more than 6,000 lives. In 1893, nearly 2,000 people were killed in Louisiana and 1,000 in South Carolina by two separate hurricanes. Hurricane Camille (1969), with sustained winds of at least 180 mph, produced a storm surge of 23 feet in Pass Christian, Mississippi and killed 172 people in Mississippi and 9 in Louisiana.

Expected levels of damage for a given hurricane intensity are described by the *Saffir-Simpson Hurricane Scale*. It was devised in 1971 by Herbert Saffir, an engineer in Miami, for the World Meteorological Organization. Robert Simpson, the director of the National Hurricane Center, then added the storm surge portion. This scale classifies hurricanes into five categories according to central pressure, maximum sustained winds, storm surge, and expected damage (Table 3.4). Although all categories are dangerous, categories 3, 4, and 5 are considered *major hurricanes*, with potential for widespread devastation and loss of life. Whereas only 21 percent of U.S. land-falling tropical systems are major hurricanes, they historically account for 83 percent of hurricane damage. Note that the scale is not linear. A Category 3 hurricane causes 50 times as much damage as a Category 1, and a Category 4 is 250 times more destructive than a Category 1.

Table 3.4. The Saffir-Simpson Scale for Atlantic hurricanes.

Category	Central pressure (approx) mb inches	Maximum sustained* winds (mph)	Storm surge in feet (approx)	Potential Damage Scale	Damage
1 Minimal	> 979	74-95	4-5	1	Damage primarily to shrubbery, trees, foliage, and unanchored mobile homes. No real damage to building structures. Low-lying coastal roads inundated, minor pier damage, some small craft in exposed anchorages torn from moorings
2 Moderate	965-979	96-110	6-8	10	Considerable damage to shrubbery and tree foliage; some trees blown down and major damage to exposed mobile homes. Some damage to roofing, windows, and doors of buildings. Coastal roads and low-lying escape routes inland cut by rising water two to four hours before arrival of hurricane center. Considerable pier damage, marinas flooded, small craft torn from moorings. Evacuation of shoreline residences and low-lying island areas required.
3 Extensive	945-964	111-130	9-12	50	Large trees blown down. Foliage removed from trees. Structural damage to small buildings, mobile homes destroyed. Serious flooding at coast and many smaller coastal structures destroyed. Larger coastal structures damaged by battering waves and floating debris. Low-lying inland escape routes cut by rising waters 3-5 hours before arrival of hurricane center. Low-lying inland areas flooded eight miles or more. Evacuation of low-lying structures within several blocks of shoreline possibly required.
4 Extreme	920-944	131-155	13-18	250	All signs blown down. Extensive damage to roofing, windows, and doors. Complete failure of roofs on smaller buildings. Flat terrain 10 feet or less above sea level flooded as far as 6 miles inland. Major damage to lower floors of coastal buildings from flooding, battering waves, and floating debris. Major erosion of beaches. Massive evacuation: all residences within 500 yards of shore and single-story residences on low ground within two miles of shore.
5 Catastrophic	< 920	> 155	> 18	500	Severe and extensive damage to residences and buildings. Small buildings overturned or blown away. Severe damage to windows and doors; complete roof failure on homes and industrial buildings. Major damage to lower floors of all structures less than 15 feet above sea level. Flooding inland as far as 10 miles. Inland escape routes cut 3-5 hours before arrival of storm center. Massive evacuation of residential areas on low ground within 5-10 miles of shore.

\* Note: In practice, the maximum wind speed determines the category. Many factors affect central pressure and storm surge, so these values are only estimates for a particular category. In fact, the storm surge may vary by a factor of two depending on the coastline's proximity to deep or shallow water. "Potential Damage Scale" provides a scale relative to a category 1 hurricane, where a category 1 hurricane is scaled as "1." For example, a Category 3 hurricane typically causes 50 times as much damage as a Category 1 hurricane.

Tornado damage is also categorized by a scale, known as the *Fujita scale*, ranging from F0 to F6. The first three categories (F0, F1, and F2) have winds of 40-72, 73-112, and 113-157 mph, respectively. While useful for identifying and categorizing tornado damage and intensity, this also means major hurricanes, in general, have the wind devastation of an F0 or F1 tornado but over a wider region! In fact, the National Weather Service issued tornado warnings through the impacted regions because Katrina had F0 and F1-like winds.

## Meteorological and storm surge characteristics of Katrina

### *I. Katrina's windfield*

Because Katrina caused unprecedented large-scale damage, it is difficult for some to believe the storm was either a marginal Category 4 hurricane or strong Category 3 hurricane. However, post-analysis shows a potent but weakening major hurricane. Katrina, which was a huge Category 5 hurricane the day before landfall, had experienced some dry air intrusion, and perhaps slightly cooler water temperatures. National Oceanic and Atmospheric Administration (NOAA) reconnaissance aircraft measured the hurricane's wind structure with Doppler radar, and found that Katrina experienced structural changes between August 28 and 29 (Fig. 3.5). Specifically, by August 29 the vertical eyewall structure broadened developing slightly weaker eyewall winds but stronger outer-core winds. Furthermore, unusually strong winds 1-3 miles aloft developed east of the hurricane right before landfall.

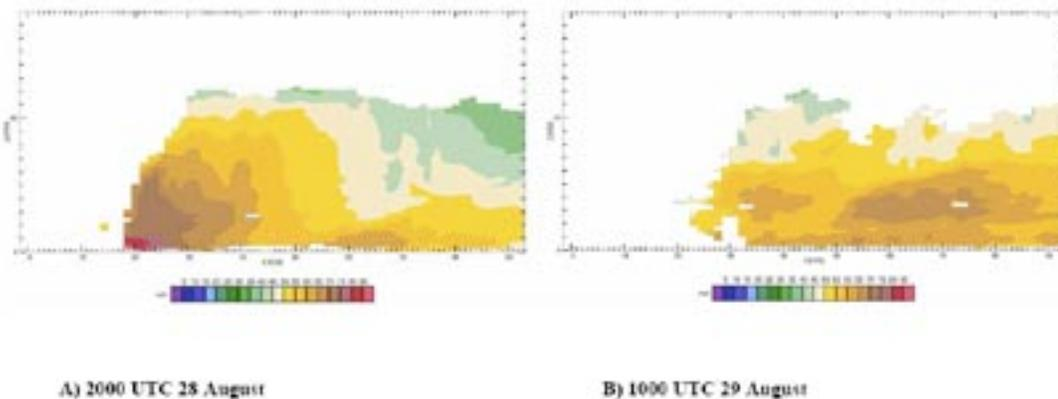

Figure 3.5. Airborne Doppler-derived radar wind speed cross-sections for August 28 and August 29 of Hurricane Katrina.

In Figure 3.5, the hurricane is shown extending from the center eastward. Note the broad and elevated wind maximum 2-4 km aloft 60 km east of the hurricane which was not present on August 28. Also note that the surface winds are stronger east of the hurricane on August 29 even though the storm's maximum eyewall winds weakened to a Category 3 level.

## FINAL REVIEW

Katrina was a major hurricane at landfall. Because it was also a large hurricane, Mississippi and Louisiana were exposed to hurricane-force winds for many hours. The strong winds aloft also created a situation where unusually potent wind gusts could occur. The widespread wind damage is likely due to the longevity of hurricane-force wind exposure and fierce wind gusts, as well as isolated tornadoes, and possibly mesovortices. The actual intensity at Mississippi landfall is still the subject of debate. On this issue, this report includes discussion of the National Hurricane Center (NHC) analysis, as well as its own analyses.

Table 3.5 shows the maximum sustained surface winds and/or maximum wind gusts from a variety of stations, including official National Weather Service platforms, NOAA buoys, mobile mesonets from several universities, Emergency Operations Centers, and other sources. Of particular significance are the reconnaissance aircraft dropsondes, which measure wind profiles to the surface as they fall from the plane. A few fell in or near the eyewall, and are shown in the table. Generally speaking, these are the only official observations which measured eyewall winds, since most other platforms failed. The authors estimate the dropsondes measured sustained winds between 100 and 110 knots (115 and 127 mph) 1-2 hours before Mississippi landfall. However, NHC estimates dropsonde winds between 95 and 105 knots. The difference depends on how one extrapolates 33-ft winds, since observations rarely occur at this level. The NHC undoubtedly was also influenced by a remote sensing instrument on a NOAA research reconnaissance aircraft which can measure surface winds called a Stepped Frequency Microwave Radiometer (SFMR). The SFMR measured peak surface winds of 96 knots at 5AM August 29. However, the SFMR is experimental and is still being calibrated.

Other measurements were obtained from mobile university “mesonet” platforms. Of particular interest is a Texas Tech mesonet at the Stennis Space Center airport, which measured maximum sustained winds of 68 mph. This observation is probably too low, indicating a negative bias in the instrument, especially since gusts of 117 mph were also measured. Nevertheless, this also indicates a Category 3 hurricane at landfall. Given this and other information, and postulating that the strongest winds were not sampled within 10-20% of the observed values, NHC estimated Katrina had maximum sustained surface winds of 120 mph somewhere in the eyewall during Mississippi landfall at 9:45AM August 29, a strong Category 3 hurricane.

Spatial distribution of hurricane surface winds is determined by the HRC Hurricane Research Division using software called H\*WIND. This code computes the 33-foot winds based on all available reconnaissance and surface observations, constrained by physics and time-averaging techniques. The HRD winds for select coastal locations at Mississippi landfall, as well as the NHC maximum estimated winds (assumed in Waveland, MS), are shown in Table 3.6. Higher winds occurred in some regions, but were not recorded due to instrument failures. Multiply tabular values by 1.15 to obtain mph. Times are represented by Coordinated Universal Time (UTC); to obtain local time, subtract 5 hours. Times of gusts are in parenthesis.

Table 3.5. Maximum observed sustained winds and wind gusts

Station	Wind Speed (knots)		Time (UTC)
	Sustained	Gust	
<i>Mississippi observations</i>			
Pascagoula	38	44	953 (933)
Biloxi-Keesler	52	85	1400 (1400)
Gulfport	40	55	1025 (1008)
Pascagoula-Jackson County EOC		108	
Poplarville Pearl River Country EOC		117	
Texas Tech tower, Stennis Space Center	59	102	1500
FIU tower, Trent Lott airport	64		1549
NWS Jackson	56		2014
Columbus AFB	50		0100 (30 <sup>th</sup> )
Greenwood	46		2153
Greenville	44		2223
Ellisville		114	(1830)
Laurel		110	(1900)
Hattiesburg		100	(1800)
Columbia		81	(1800)
Starkville		76	(0030) 30 <sup>th</sup>
Pascagoula (Univ S.Ala mesonet)	58	66	1413
Pascagoula (FL Coast Mon. Prog. Mesonet)	64		1549
Lauderdale	70		2051
NHC dropsonde, Near Grand Island, Miss. Sound	105 (est)		1315

**FINAL REVIEW**

NHC dropsonde, Petit Bois Island, MS	105 (est)		1424
Station	Wind Speed (Knots)		Time (UTC)
	Sustained	Gust	
NHC dropsonde, Cat Island Channel, MS	95 (est)		1454
<i>Louisiana observations</i>			
Slidell KASD	32	44	1243 (1243)
Bootheville	26	39	2137 (2137)
New Orleans airport	64		1405
New Orleans lakefront airport	60	75	1340 (1405)
Southwest Pass CMAN	72	88	0446 (0446)
Grand Isle CMAN	62	99	0747 (0838)
Buoy 42007	60	74	1535 (1354)
Terrebonne Bay buoy	55		1000
Lake Pontchartrain midlake	68	86	1520 (1520)
Slidell (Videographer at Memorial Hospital)		105	1435
LSU BTR-BEN	43	54	1438 (1414)
NASA Michoud	84		1100
LSU- BTR- BURDEN	34	48	1404 (1519)
LSU PT SULPHUR	75	88	0937 (0937)
LSU FRANKLINTON	43	69	1915 (1800)
LSU HOUMA	44	60	1100 (1535)

**FINAL REVIEW**

LSU HAMMOND	48	66	1644 (1643)
Station	Wind Speed (knots)		Time (UTC)
	Sustained	Gust	
LSU LIVINGSTON-S	35	49	(1431)
LSU MANCHAC	59	74	1559
LSU LIVINGSTON-W		42	(1451)
LSU ST. GABRIEL	44	53	(1519)
Texas Tech tower, Slidell Airport	61	87	1500
Texas Tech tower, Vacherie	48	64	1200
FIU tower, Belle Chase	68	89	1427 (1132)
FIU tower, Galliano	67	83	0936 (0935)
NHC dropsonde, near Rigolets	85 (est)		1339
NHC dropsonde, Franklington, LA	80 (est)		1354
NHC dropsonde, Chandeleur Sound	100 (est)		1404
NHC dropsonde, Delacroix, LA	80 (est)		1401
NHC dropsonde, 12 miles east of Point Chicot, LA	90 (est)		1417
NHC dropsonde, Mitchell Key, LA	110 (est)		1451
NHC dropsonde, Point Chicot, LA	85 (est)		1505
<i>Alabama and Florida panhandle observations</i>			
Mobile airport	57	72	1608 (1608)

## FINAL REVIEW

Brookley Field	58	73	1501 (1501)
Station	Wind Speed (Knots)		Time (UTC)
	Sustained	Gust	
Pensacola airport	49	60	1451 (1451)
Pensacola Naval Air Station	49	62	1812 (1812)
Dauphin Island	64	89	1542 (1542)
Mobile Bay (USS Alabama)		90	

Hurricane intensity can also be estimated based on structural damage assessments. Based on experiences with tornado damage, a “Damage Indicator” (DI) has been developed which correlates visual damage to wind speed. This technique defines 28 categories of buildings, structures, and trees such as small barns, small family residences, single-wide manufactured homes, large shopping mall, hardwood trees, etc. Then 7-10 “degrees of damage” (DOD) are defined for each category, from minor damage to total destruction, based on well-defined description for that category (for example, collapse of chimney on a small residence is a DOD of 4 while total destruction is a 10). These DODs are then correlated to a wind speed value with an expected margin of estimation error.

Haag Engineering conducted surveys of the Mississippi Gulf Coast using the DI technique, and voluntarily provided Mississippi State University their wind damage assessment. Generally speaking, since the DI methodology is based on building damage due to brief strong winds, these estimates actually represent wind gusts. These estimated wind gusts are shown in Table 3.6.

Wind is ultimately driven by pressure differences. Therefore, it is theoretically possible to compute wind based on surface pressure measurements. An advantage is that often pressure observations are still measured even after electricity is lost, or after a wind anemometer is damaged. However, the effect of surface friction needs to be included, an imprecise factor, and often asymmetries in the pressure field are difficult to incorporate. Nevertheless, this calculation serves as a useful comparison to the NHC, HRD, and Haag Engineering analysis using the DI technique. Pressure measurements are available in Mobile, Dauphin Island, Pascagoula, Biloxi, the hurricane eye, and several locations in Louisiana. No pressure measurements are available in the eyewall, but one can assume a pressure profile based on the fact the pressure differences are greatest in the eyewall itself. Then, using a mathematical formula known as the “gradient wind equation,” and assuming a 20% reduction in the eyewall (but 10% outside the eyewall based on Figure 3.5), wind estimates are shown in Table 3.6 for Mississippi landfall, as well as Slidell, LA just to the west of the eye, along the immediate coastline. Generally speaking, estimated values are slightly higher than the NHC and HRD values, but still Category 3 strength. Even a few miles inland, sustained winds will be lower than shown here, since hurricane winds weaken rapidly once inland.

## FINAL REVIEW

Table 3.6. Estimated maximum wind speeds and/or gusts (mph) (from NHC, Haag Engineering, and these writers. Valid for immediate coastline.)

Location	NHC (2006) and HRD (2006) sustained winds (mph)	Haag <sup>1</sup> wind gusts (mph)	Sustained winds (mph) based on pressure patterns. (Estimated gusts)
Slidell, LA	90	105	90 (105)
Waveland, MS	120	122	125 (130)
Biloxi, MS	90	110	100 (115)
Ocean Springs, MS	80	105	85 (105)
Pascagoula, MS	70	100	80 (100)

Also shown in Table 3.6 are estimated wind gusts. Because of the strong winds aloft outside the hurricane eyewall, one may assume that turbulent eddies will effectively transport much of this momentum to the ground in brief but powerful spurts. Generally speaking, wind gusts are 20-30% larger than sustained winds, and these values are reflected in the table. Smaller wind gusts are indicated in Waveland, MS, since the vertical cohesion of the hurricane eyewall has been lost. Indeed, strong wind gusts were observed far inland in east Louisiana and Mississippi, with incredible tree and structural damage all the way to Laurel, MS, just east of the eye's path. Mobile Doppler radar measured strong winds aloft which can cause strong downburst activity inland (Figure 3.6). Poplarville, MS, in the vicinity of the 125 mph winds 3000-feet aloft shown in this figure, experienced some of the worst wind damage away from the coast. Note the maximum value of 132 mph between 3000 and 4000 feet above ground level during the morning hours. It is estimated that eighty to ninety percent (approximately 104-119 mph) of the latter maximum wind speed value reached the ground in the vicinity of Poplarville, MS.

### *II. Tornado activity and downbursts in Katrina*

Tornadoes are documented either by Doppler radar, post-storm surveys, or by eyewitness accounts (particularly trained "weather spotters"). Tornado documentation thus far in Katrina has been lacking from the National Weather Service and storm spotters.

Officially 11 tornadoes were reported in Mississippi, mostly far inland. The Haag Engineering Group has noted little evidence of tornadoes on the Mississippi coast during their surveys, although collecting tornado information hasn't been a high priority area of their investigations. Eyewitness accounts and speculation on tornado occurrences have had little formal documentation. As a result, one is left with using Doppler radar as a tool to identify potential tornado occurrences at landfall.

<sup>1</sup> Personal communication, Haag Engineering Co., Carrollton, TX

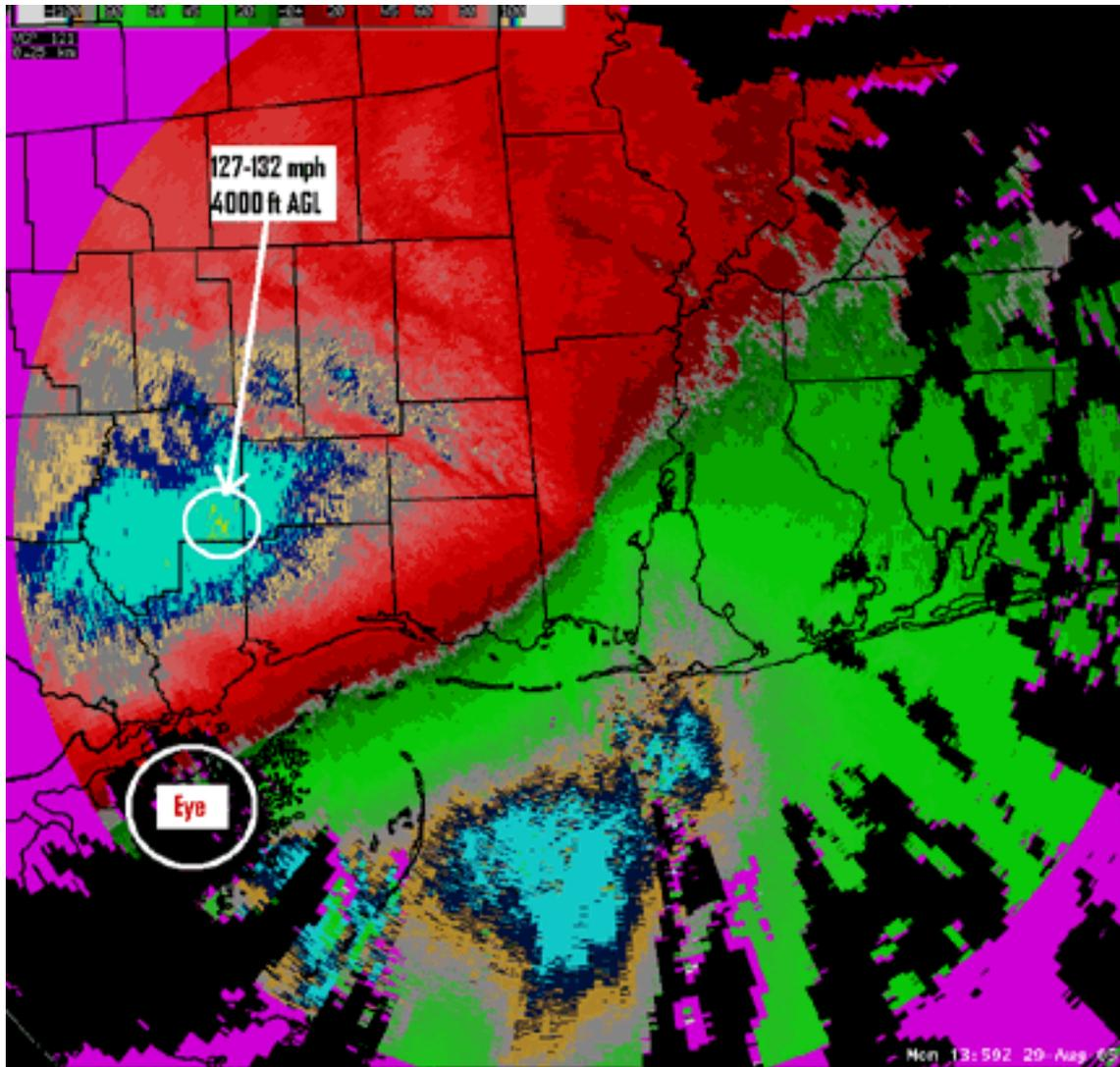

Figure 3.6. Mobile WSR-88D single-Doppler radar in Mobile (KMOB WSR-88D) radial wind measurements.

Doppler radar measures radial velocity and precipitation intensity (reflectivity) which are input into automated algorithms. One algorithm attempts to identify *mesocyclones*, defined as rotation in a thunderstorm, typically around 2-6 miles in diameter, and associated with an existing tornado or potential tornado formation. The circulation of a mesocyclone covers an area much larger than the tornado that may develop within it. Doppler Radar includes the *Mesocyclone Detection Algorithm* which identifies circulations in thunderstorms that have the potential to spawn tornadoes. The software identifies Doppler velocity differences of 25–75 m s<sup>-1</sup> across core diameters of 2–8 km, with resulting azimuthal shear values of  $5 \times 10^{-3} \text{ s}^{-1}$  to  $2 \times 10^{-2} \text{ s}^{-1}$ . It also looks for symmetry in the signal before being identified as a possible mesocyclone.

## FINAL REVIEW

Unfortunately, there is a degree of uncertainty associated with the mesocyclone algorithm. The software was developed for mid-latitude, inland severe thunderstorms, not hurricanes. Furthermore, hurricane mesocyclones tend to be small, shallow, and weak, resulting in a low probability of detection. Finally, many mesocyclones do not produce tornadoes. Actual observed mesocyclones (not radar-detected) show 10-30% of mesocyclones in the Great Plains produce tornadoes. It's not known what the percentage is for radar detections under similar conditions or under hurricane conditions. In summary, not all mesocyclones are detected in hurricanes, and only a small fraction of radar-detected mesocyclones spawn tornadoes.

With these caveats, Slidell and Mobile Doppler radar detected mesocyclone activity. The Mobile radar was operational throughout Katrina's landfall, while Slidell quit operating around 1400 UTC (9AM). Figure 3.7 shows the Mobile mesocyclone signatures between 3:30AM to 12:45PM, and Figure 3.8 shows Slidell mesocyclone signals between 3:30AM and 9AM. While most hurricane mesocyclones (as well as tornadoes) have a short lifespan, undoubtedly some of these signals are associated with the same mesocyclone. No attempt is made to differentiate duplicate mesocyclones or to plot their tracks. There were 55 mesocyclone signal detections for the Slidell radar, while 68 were detected by the Mobile radar. When one accounts for the uncertainties involving the ratio of tornadoes to mesocyclones, duplicate mesocyclones, and unseen mesocyclones, one could estimate 10-20 tornadoes occurred between 3:30AM and 9AM in the range of the Slidell radar, and a similar number between 3:30AM and 12:45PM within the Mobile's radar range. Certainly other activity is possible before and after these periods. A noticeable dearth of mesocyclones is seen north of Lake Pontchartrain due to Slidell radar power outage. This writer can vouch for at least one tornado near his place of evacuation at Bush, LA, where parts of a metal roof pierced a tree with a nearby swath of trees cut in half.

Downburst winds also contributed to wind damage. While diagnosing downbursts is difficult in these circumstances, Haag Engineering noted some downburst activity, especially near mile marker 11 on I-10.

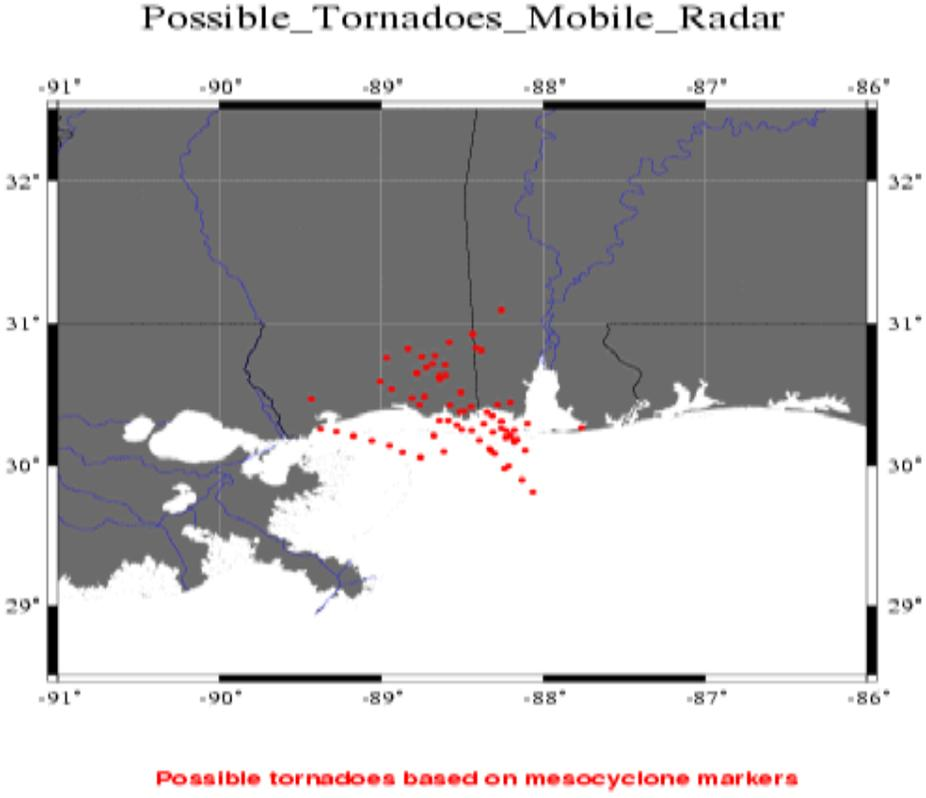

Figure 3.7. Mesocyclone signatures detected by the Mobile Doppler radar between 3:30AM to 12:45PM.

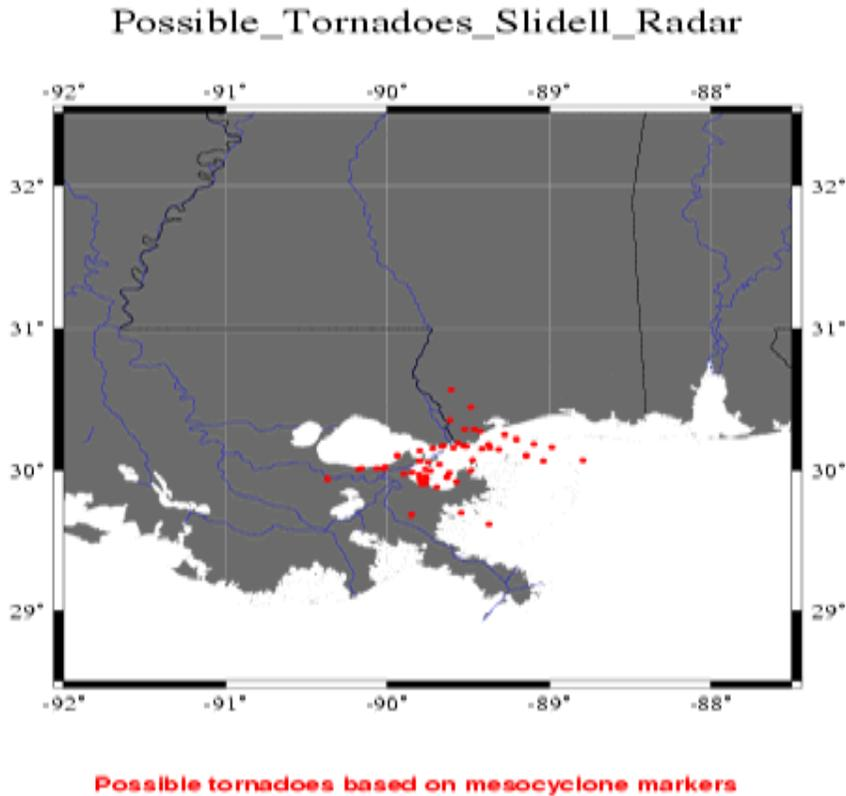

Figure 3.8. Mesocyclone signatures detected by the Slidell Doppler radar between 3:30AM to 9:00AM. (Slidell radar went out of commission after 9AM.)

### *III. Mesovortices in Katrina*

Thus far, little information is available on mesovortices in Katrina. National Hurricane Center discussion advisories do not mention any mesovortex activity. However, NASA's polar-orbiting Terra and Aqua satellites, which have a MODIS sensor with resolution of 250 meters, can see these in a clear eye. A MODIS image with 250-meter resolution image, zoomed in on Katrina's eyewall at 12:15PM on August 28, shows possible eyewall mesovortices when Katrina was 200 miles from southeast Louisiana as shown in Figure 3.9.

Unfortunately, because polar-orbiting satellites can only take one image in the same geographical region per day, no MODIS images are available when Katrina was off the

Mississippi coast. Research and limited observation studies show that intense hurricanes such as Katrina commonly contain mesovortices. As a result mesovortices probably occurred during landfall on the Mississippi coast.



Figure 3.9. NASA satellite image from Terra's MODIS sensor on August 28, 2005, at 12:00 PM.

IV. Storm surge in Katrina

Observations of Katrina’s storm surge life cycle generally do not exist because all tide gauges failed in the southeast Louisiana marsh and along the Mississippi coast during the brunt of the storm. The previous few days of water levels, as well the first few hours of the storm surge, were documented. A typical example is seen in Figure 3.10, which depicts water levels at the Paris Road tide gauge near Chalmette, LA, where some of Katrina’s worse storm surge occurred, totally inundating all of St. Bernard Parish. Several days before Katrina, the primary signal is the diurnal tide range. One day before landfall, the water increased 2-3 feet. This effect is known as the *surge forerunner*. On the day of landfall, water level increased slowly at and then rose suddenly within a few hours to a level of 12 feet. Then the gauge failed.

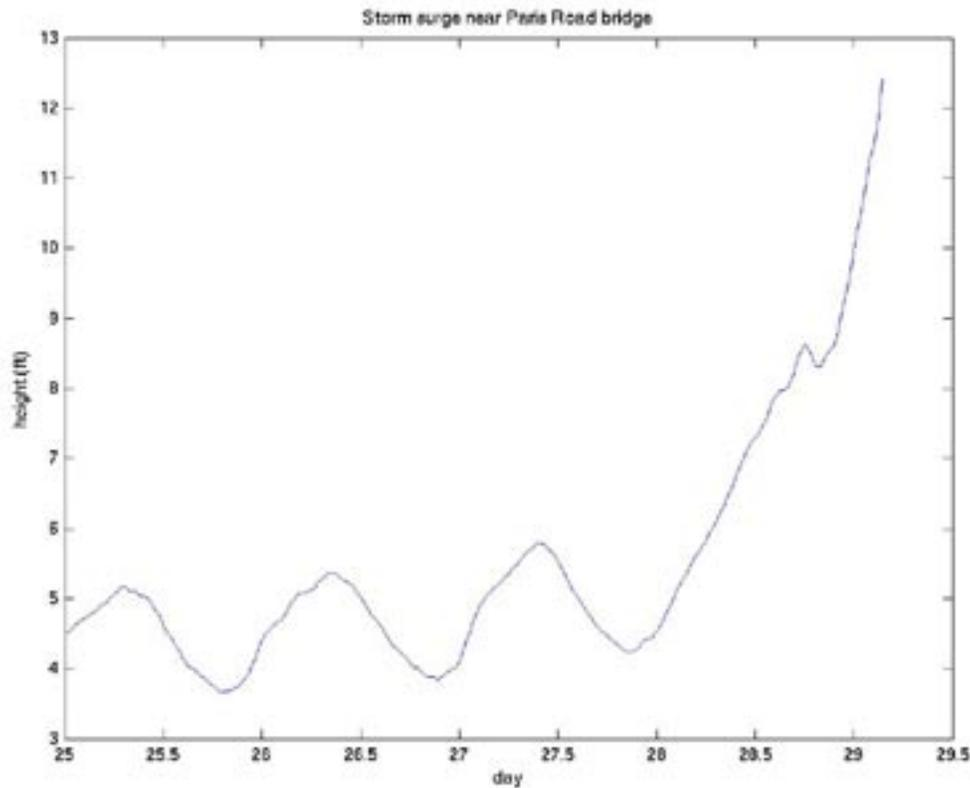

Figure 3.10. Time series plot of water elevations at the Paris Road, tide gauge, near Chalmette, LA from midnight August 25 to 8AM August 29.

Since observations are lacking, two methods exist to document the storm surge: computer model simulations, and post-storm high-water measurements. A computer model approximates time-dependent hydrodynamic equations which represent water flow driven by wind and pressure fields. It can be used to explore the qualitative evolution of the storm surge, to fill in data gaps, and to explore physical relationships. High water mark surveys are typically conducted by government agencies (such as the National Weather

## FINAL REVIEW

Service, the Army Corps of Engineers, and the USGS) and private companies such as URS and Haag Engineering. The measured high water marks reflect either the stillwater elevation of the storm surge (areas outside the influence of breaking wave and wave runup, either far inland or inside buildings) or the stillwater elevation plus the wave runup component (areas in the wave swash zone - either breaking waves or wave runup). The stillwater elevation is generally measured inside commercial or residential structures as mud lines on walls or doors. The storm surge plus wave runup high water marks are generally found as debris or trash lines along coastal dunes, sloping terrain of the bay shoreline or the exterior of structures. Both are discussed here.

The U.S. Army Corps of Engineers ADvanced CIRCulation (ADCIRC) fully nonlinear hydrodynamic model (Luettich and Westerink, 2000) was used to simulate Katrina's storm surge. ADCIRC was initially developed under the Dredging Research Program, a 6-year program funded by the Army Corps of Engineers, Office of the Chief of Engineers. The model was developed as a family of 2- and 3-dimensional finite element based codes with the capability of simulating tidal circulation and storm surge propagation over very large computational domains, while simultaneously providing high-resolution output in areas of complex shoreline and bathymetry. The code has recently been parallelized to obtain faster simulations. The 2D version uses the vertically averaged equations of mass and momentum conservation, subject to the hydrostatic approximation, and reformulated into a generalized wave continuity equation to avoid spurious oscillations associated with the primitive variable equations. Wind and pressure forcing is provided by a wind parametric boundary layer model.

One advantage of using ADCIRC over other storm surge models, such as SLOSH, is that input conditions can include all or part of wind stress, atmospheric pressure, tides, wave stress, and river discharge, which serves to make the model output more accurate. A second benefit is due to the finite element structure of the grid, which allows increasingly higher resolution towards the coastline. The finite element method allows increased nodal density in shallow water regions while maintaining a coarser resolution in deeper waters, which leads to savings in computational time. A third advantage is that the geometric complexity of the coastline can be accurately represented without changing the coordinate system. Thus, rivers and coastal embayments are readily incorporated into the domain, as can hypothetical levee systems. In collaborations with WorldWinds, Inc., ADCIRC has been used to perform 100 storm surge scenarios in Biloxi Bay in one study (Jacobsen et al., 2005), and to examine the sensitivity of the storm surge to the Mississippi River Gulf Outlet in another research task.

It should be noted that the ADCIRC simulation shown in this report was done with a more intense hurricane, since earlier estimates from NHC indicated a Category 4 hurricane. However, while actual surge elevations will be lower, the overall physics of the simulation will not change. A new simulation is currently being prepared for future reports.

## FINAL REVIEW

Figure 3.11 shows the 5AM output of ADCIRC Extending eastward from the northshore of Lake Pontchartrain, LA to Mobile Bay, AL. The surge can be seen moving up the Pearl River, Jordan River, and Biloxi River. Marsh regions near Pearlington and Pascagoula begin to experience inundation. Islands offshore, as well as Dauphin Island in Alabama, are partially underwater. A few areas have surge levels greater than 5 ft; however, the surge is below 5 feet in most regions. At 6AM and 7AM, this pattern continues, but with surge values above 10 feet in some regions (Figures 3.12 and 3.13). By 8AM, Pass Christian westward begins to experience inundation (Figure 3.14). Note that a water elevation deficit is actually occurring along the northshore of Lake Pontchartrain since Katrina's north winds are pushing waters south. By 9AM, significant storm surge is occurring along the Mississippi coast, with 15 to 25 feet water elevations penetrating miles inland west of Bay St. Louis (Figure 3.14). Significant surge is also seen at Biloxi, Ocean Springs, and Mobile Bay. Because the wind direction is shifting west of the region, water from Lake Pontchartrain is also starting to push eastward, causing a second wave of inundation in that region.

The peak surge occurs during the 10AM to 11AM period (Figures 3.16 and 3.17), with extreme inland penetration and record surge values on the order of 25-35 feet. At this time, Slidell and the Pearl River region are now experiencing a major surge as water sloshes eastward in Lake Pontchartrain associated with the wind shift. Damage to the "twin spans" bridge system which connects Slidell and New Orleans indicates an outward surge, with much of the damage on the east of the bridge system. By 12PM and 1PM, the surge is beginning to recede (Figures 3.18 and 3.19).

The massive storm surge produced by Katrina was greater than that produced by Camille, even though Katrina was less intense. Katrina was a huge storm and moved slower than Camille. NHC also hypothesizes that the hurricane's recent Category 5 status the day before generated large wave set-up ahead of the hurricane. However, that reasoning may be incorrect. First, Hurricane Ivan (2004) was also a strong hurricane which weakened slightly before landfall, but the same storm surge values were not seen in Alabama. Second, the tide gauges show little evidence of significant wave setup ahead of the hurricane. However, the authors hypothesize that the Mississippi River levee system may have also contributed to the large surge (see discussion in later paragraphs).

Hurricane-Katrina August 29, 2005 5AM

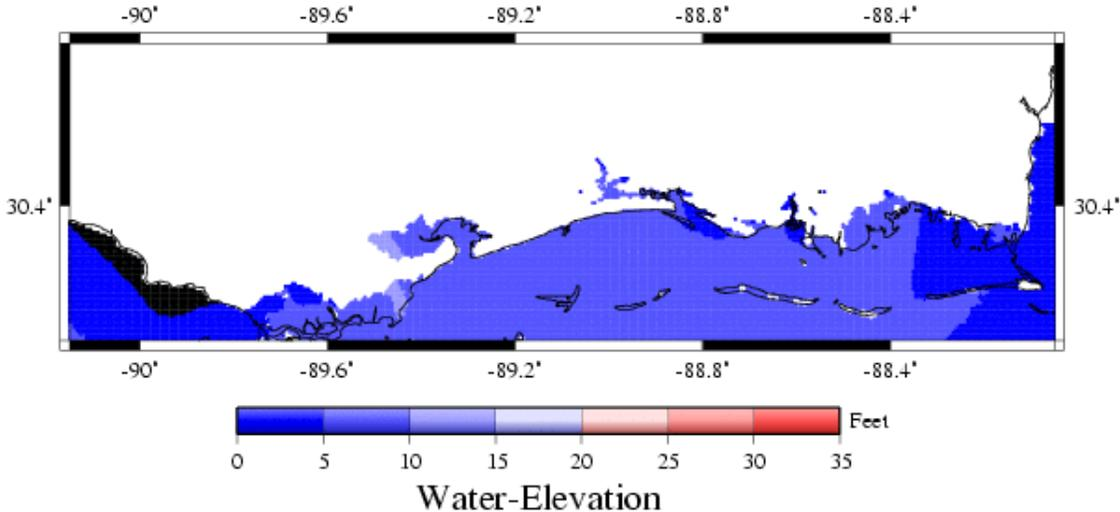

Figure 3.11. ADCIRC simulation of storm surge, valid 5AM.

Hurricane-Katrina August 29, 2005 6AM

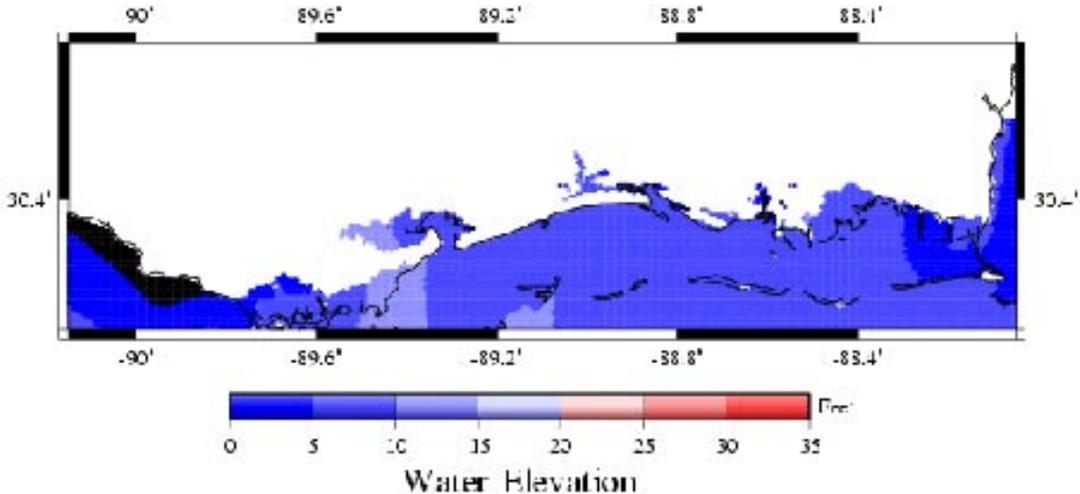

Figure 3.12. As in Figure 3.11, but 6AM.

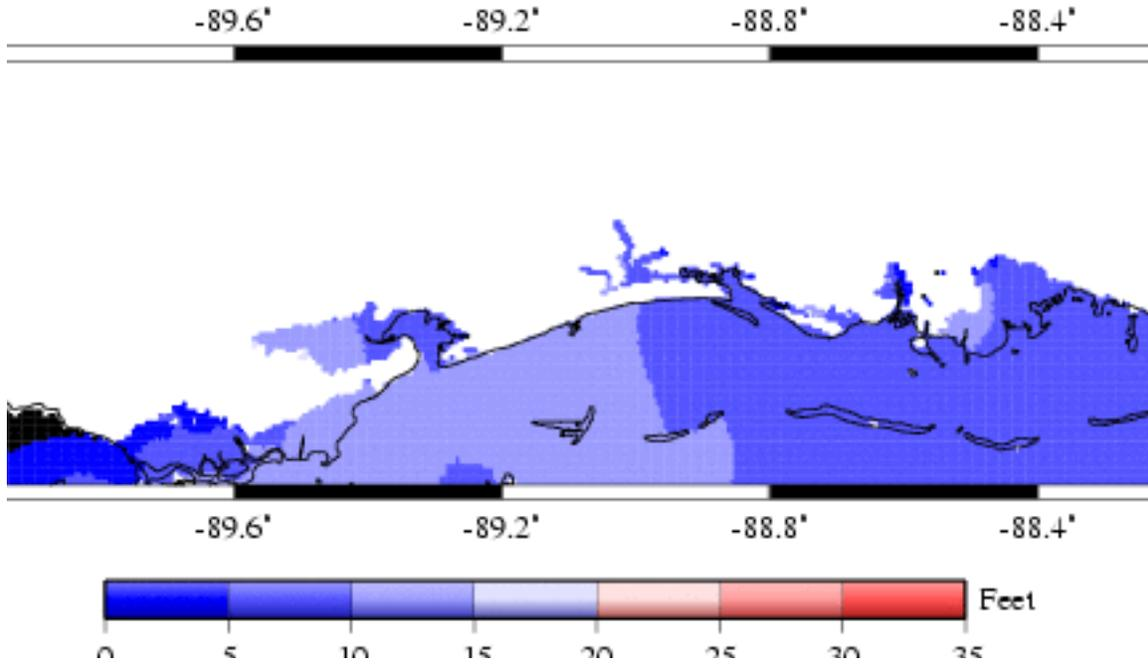

Figure 3.13. As in Figure 3.11, but 7AM.

Hurricane-Katrina August 29, 2005 6AM

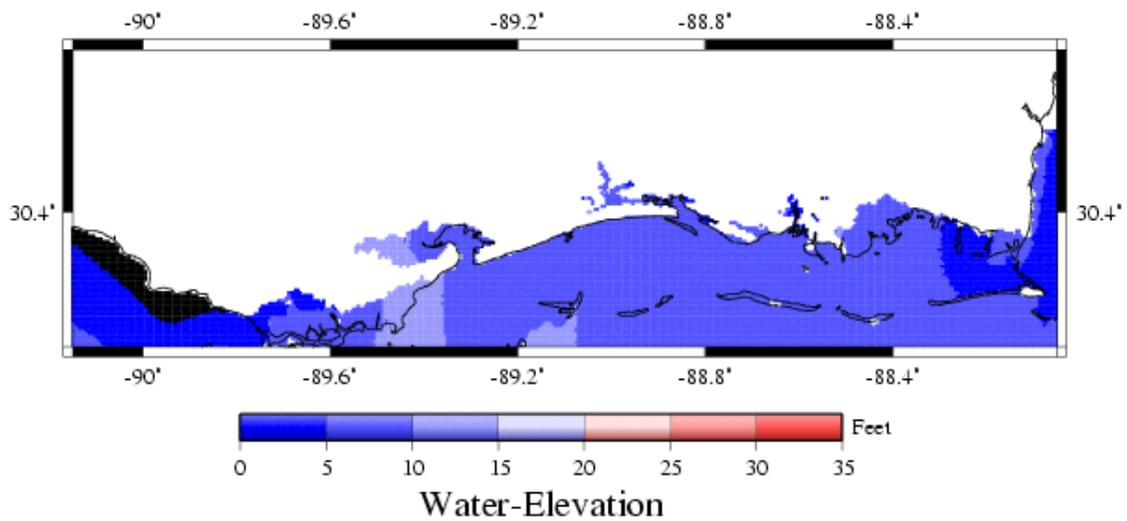

Figure 3.14. As in Figure 3.11, but 8AM.

Hurricane-Katrina August 29, 2005 9AM

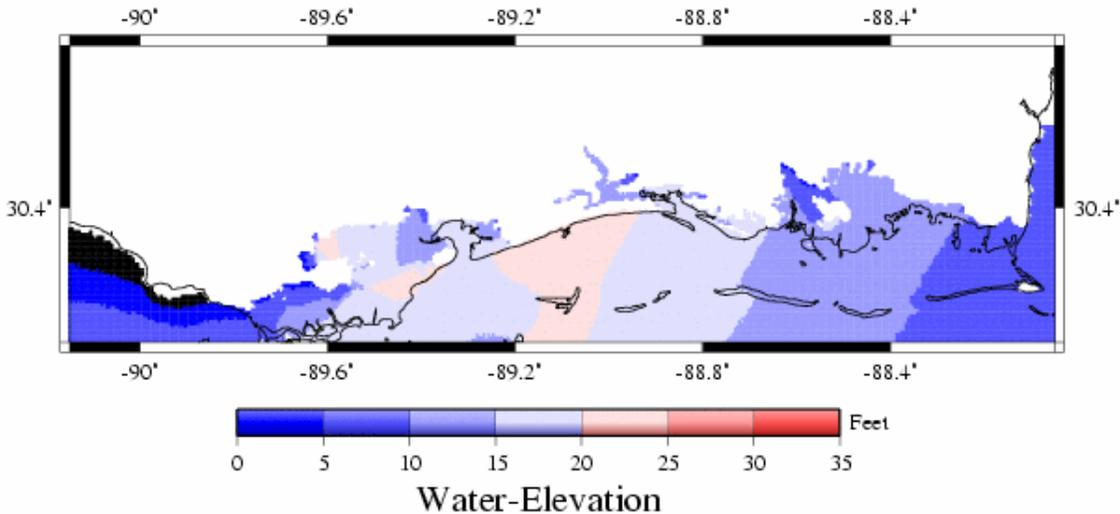

Figure 3.15. As in Figure 3.11, but 9AM.

Hurricane-Katrina August 29, 2005 10AM

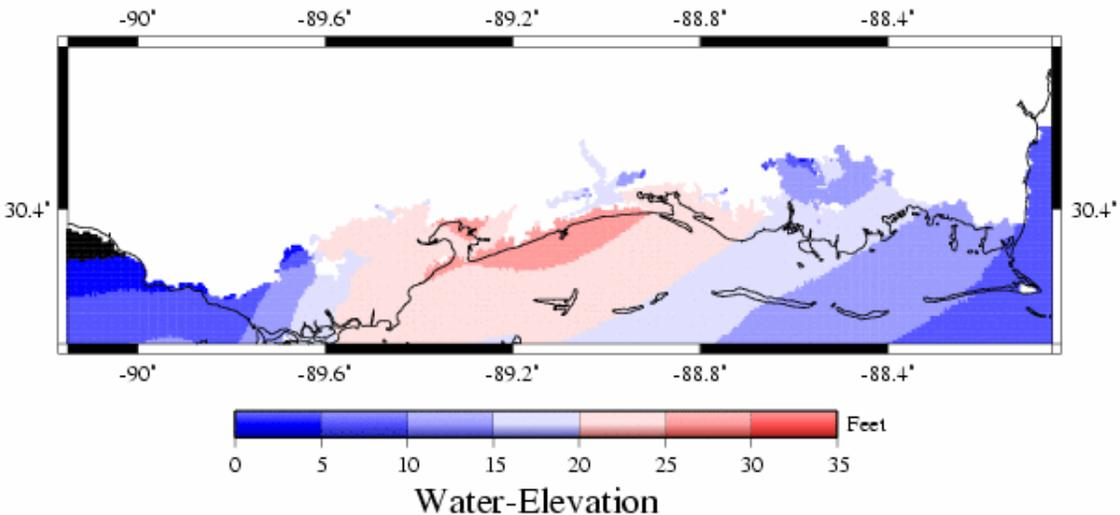

Figure 3.16. As in Figure 3.11, but 10AM.

Hurricane-Katrina August 29, 2005 11AM

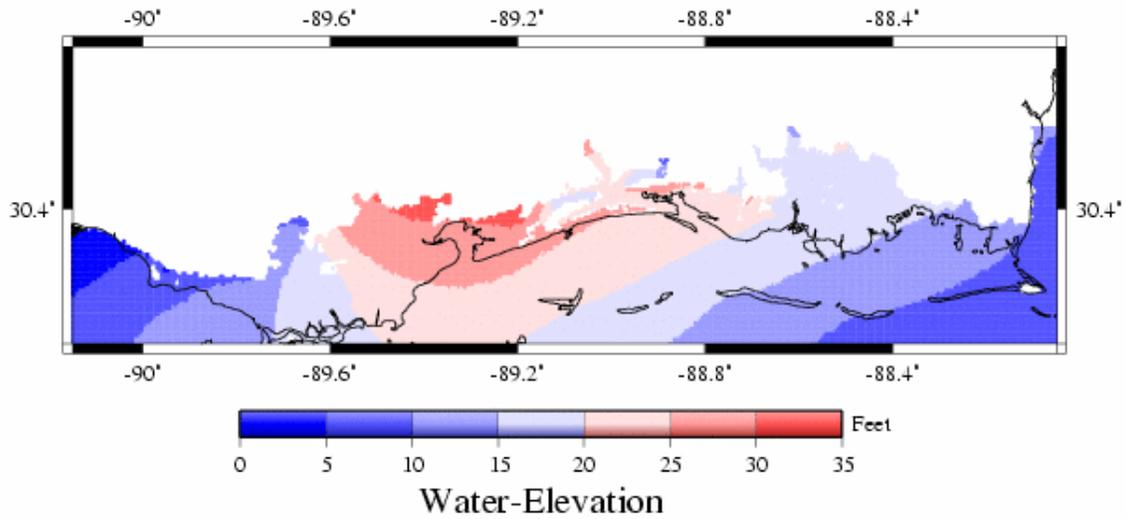

Figure 3.17. As in Figure 3.11, but 11AM.

Hurricane-Katrina August 29, 2005 12PM

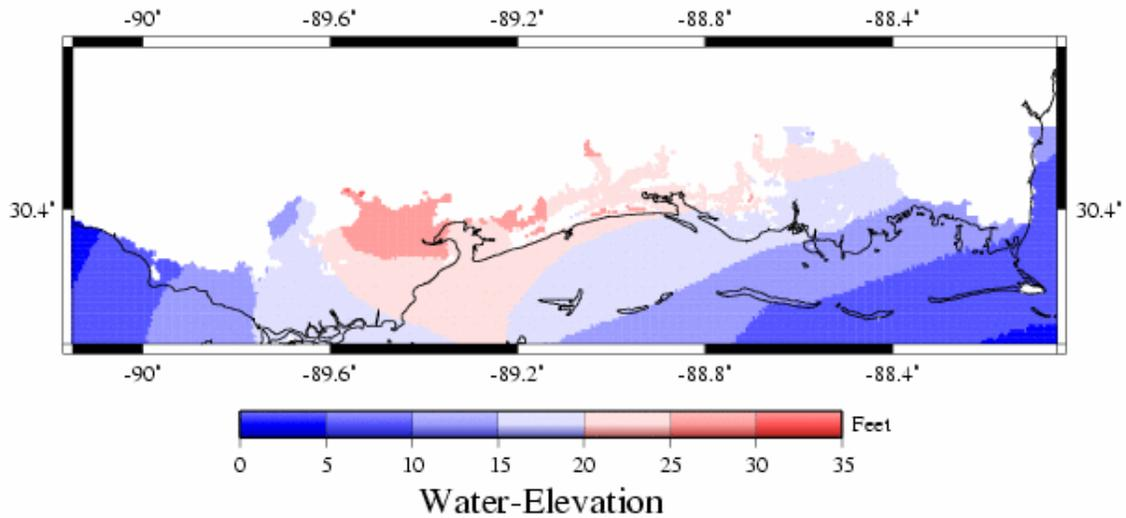

Figure 3.18. As in Figure 3.11, but 12PM.

Hurricane-Katrina August 29, 2005 1PM

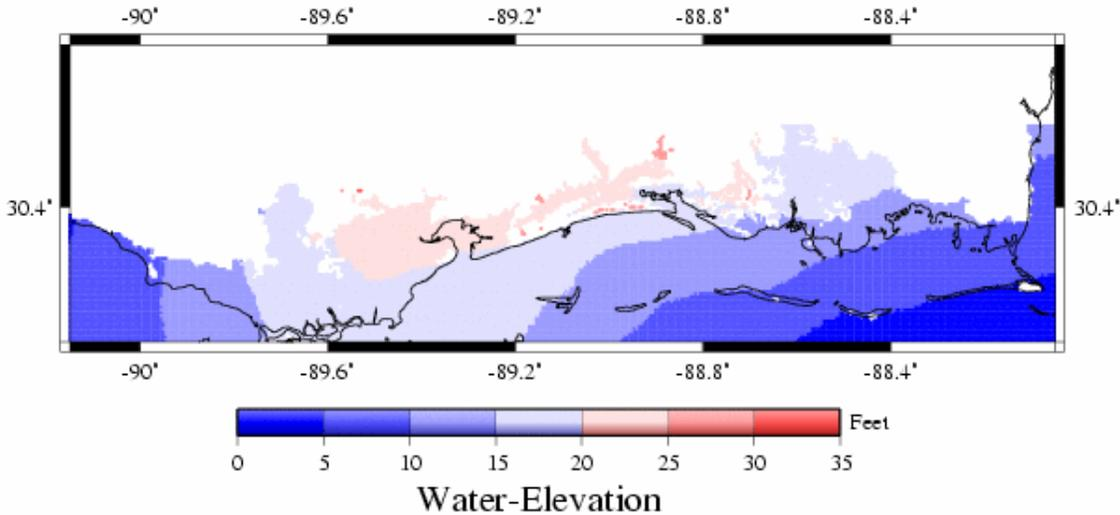

Figure 3.19. As in Figure 3.11, but 1PM.

## FINAL REVIEW

High water marks depict a similar picture as the storm surge simulations. Surge values of 28-31 feet have been documented between Pearlington and Bay St. Louis, MS (Table 3.7). Probably similar values occurred in Buras and Venice, LA, where Katrina made the first landfall. High water marks between 20 and 27 feet occurred between Bay St. Louis and Biloxi, as well as areas outside the levee system in Slidell and the Louisiana marshes east of the Mississippi River. Dramatically smaller values are seen west of landfall in Grand Isle and Fourchon, although significant damage still occurred in this region. Noticeably smaller values occurred north of Barataria Bay, such as in Lafitte, LA, implying that the levees along the Mississippi River stopped the surge from spreading westward, and perhaps concentrated the surge east of the Mississippi River. The ADCIRC simulations suggest the storm surge piled up along the river levees as Katrina moved parallel to the Mississippi River, and then moved northward with the storm (not shown). In other words, the Mississippi River levee system could have contributed to an exceedingly large storm surge since water was not allowed to spread westward. A proposal has been submitted to NASA to investigate this hypothesis.

Ocean Springs, Pascagoula, and coastal Alabama experienced smaller but still significant surge values of 12 to 19 feet. In particular, eastern Mississippi had not seen such surge values in many decades. Florida and eastern Alabama experienced surge values on the order of 5 feet.

Table 3.7. Hurricane Katrina high water marks (observed by Haag Engineering, National Weather Service (NWS), and the authors along coastal sections).

Location	Katrina high water mark (feet)	Source	Camille high-water mark (feet) (Corps of Engineers)
Buras	20-25 (estimated)	Storm surge models; eyewitness reports	15
Slidell, LA (inland)	15	Haag, Rt. 433 and HWY 90	
Slidell, LA (Lake Pontchartrain)	23	Author	8
Grand Isle, LA	12	NWS	
Port Fourchon, LA	8	NWS	
Lake Pontchartrain Causeway	6.8	NWS	
Lake Maurepas, LA	3.05	NWS	
Hopedale, LA	23	Author	
Reggio, LA	18	URS	
Lafitte, LA	4	Tide gauge	
Waveland, MS	31	HAAG – Waveland School	20

**FINAL REVIEW**

Hancock County, MS	31	EOC	
Bay St. Louis, MS	27	HAAG – Post Office on Rt. 90	21
Pass Christian, MS	25	HAAG – House on Rt. 90	22
Pass Christian, MS	28	USGS – 1320 Scenic Drive	23.4
Gulfport, MS	22	Haag – First Baptist Church on Rt. 90	21
Biloxi, MS	20	HAAG – Grand Casino	17
Biloxi, MS	24	USGS – Isle of Capri Casino	15.6
Biloxi, MS	20	USGS – House on Kennedy Lane near Damphman Point	14.2
Biloxi, MS	20	USGS – Inside Beach Mini Mart near east end of US 90 bridge	15.5
Ocean Springs, MS	19	HAAG – House on Beach BLVD	16
Pascagoula, MS	17	HAAG – House on Beach BLVD	12
SE Pascagoula, MS	15	HAAG – House near ocean	
Pascagoula, MS (PSCM6)	12.16	NWS	
Green Pass, MS	11.27	NWS	
Bayou La Batre, AL	14		8
Mobile State Docks, AL	11.45	NWS	6
Mobile Bay – USS AL	12	NWS estimated	
Dauphin Island, AL	6.63	NWS	
Dauphin Island, AL	6.23	Tide gauge	
Perdido Pass, FL	5.81	NWS	4
Pensacola, FL	5.37	NWS	
Destin, FL	4.52	NWS	
Santa Rosa Sound, FL	4.10	NWS	

**FINAL REVIEW**

The hurricane surge penetrated up to 12 miles inland along bayou and river systems. In fact, the surge crossed Interstate 10 in many locations. Table 3.8 shows storm surge values along inland waterways.

Table 3.8. Hurricane Katrina high water marks inland along bayous (USGS). Hurricane Camille values are shown for comparison.

Location	Katrina high water mark (feet)	Source	Camille high-water mark (feet)
East Pearl River at I-10 east bridge end	15	USGS	6.9
Devils Swamp @ Box culvert at I-10 (Drains Stennis)	15	USGS	10.4
Gulf side of I-10 overpass of SR 43	24	USGS	14.6
Inland side of I-10 overpass of SR 43	23	USGS	13.8
Jourdan River at I-10 West bridge end	21	USGS	14.2
Jourdan River at Inland side of I-10 east bridge end	25	USGS	15.1
Jourdan River at Gulf side of I-10 east bridge end	28	USGS	16.9
Jourdan River at SR 43 gage (02481660)	19.8	USGS	12.2
Wolf River at I-10 west bridge end	19	USGS	13.5
Wolf River at I-10 east bridge end	19	USGS	13.5
Bernard Bayou at I-10	19	USGS	14.3
Fritz Creek at Cowan-Lorraine Road Extension (Under Construction) -- Upstream of Biloxi River at I-10	20	USGS	13.5
Tchoutacabouffa River at I-10	19	USGS	13.3

**FINAL REVIEW**

Old Fort Bayou at I-10	16	USGS	11.4
West Pascagoula River at Gulf side of I-10 West bridge end	18	USGS	
West Pascagoula River at Inland side of I-10 West bridge end	14	USGS	9.1
Escatawpa River at I-10 gage (0248018020)	10.6	USGS	4.9
Communications building on Whites Bayou (HWY90) near Pearlinton, MS	18.6	USGS	10
Tchoutacabouffa River (02480599) at SR 15 & 67 at D'Iberville (north bridge end)	17.7	USGS	12.6
Old Fort Bayou (02481299) at SR 609 (Washington Ave)	20.8	USGS	14.8
Pascagoula River at I-10 east bridge end	12.7	USGS	8.6
Pascagoula River at Gulf side of I-10 east bridge end	13	USGS	8.6
Pops Ferry Bridge, South abutment Biloxi, MS	19	USGS	13.9

The storm surge along the coast of Mississippi was unexpected because the storm was slightly weaker than Hurricane Camille (1969), the benchmark hurricane in that area. Camille also came from the south-southeast direction, whereas Katrina slammed inland directly from the south along the Louisiana-Mississippi border, probably the worst possible track for Mississippi. Katrina also moved a little slower than Camille, allowing more time for the water level to build. About 2-3 feet of the surge was due to the inverse barometer effect, and the rest was wind-driven. The surge inundated areas of Waveland and most of the Mississippi coast. For comparison, surge values from Camille are shown in Table 3.1. Fatalities in Mississippi from Katrina exceeded those of Camille.

## FINAL REVIEW

Although not directly a cause of the storm surge, Katrina's impact began at high tide, with the tide starting to fall during landfall (Figure 3.20). The tidal range during this period was 2.0 ft, which is the maximum range expected in any month, known as a *spring tide*. Such a range occurs for several days twice a month. The normal tidal range is 1.0 ft, with a *neap tide* (minimum range) occurring twice a month. Summer water elevations also are higher due to the *steric effect*. Water surface elevation is impacted by a change in water density, which in turn is related to water temperature or salinity. The steric effect causes Gulf of Mexico waters to expand in the summer due to the warm waters. This amounts to a small but non-negligible increase of 7 cm in the summer. Both contributions are small compared to the storm surge, but the fact the hurricane hit at high tide during a spring tide episode further compounded coastal inundation.

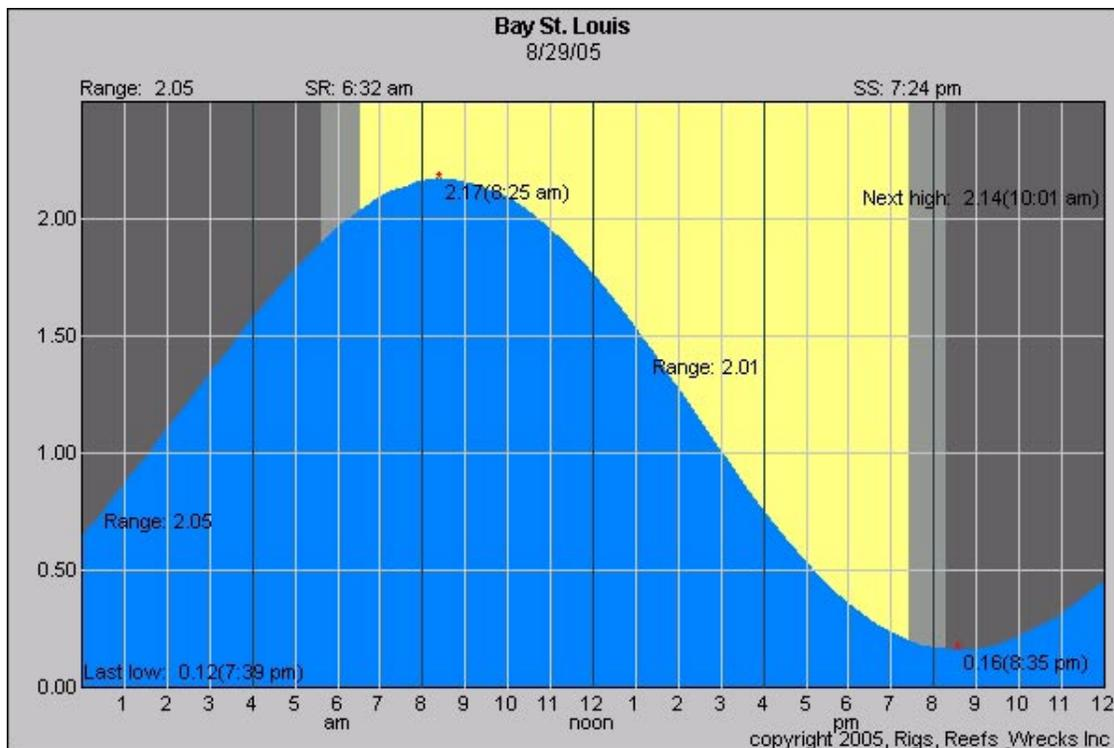

Figure 3.20. Bay St. Louis tide for August 29, 2005. (High tide occurred at 8:25AM, then fell the rest of the day but remained above mean sea level during Katrina's landfall. Courtesy of [www.rodreel.com](http://www.rodreel.com).)

Another important issue is the timing of wind versus surge. Limited tide gauge data, and eyewitness accounts, suggest that tropical storm-force winds arrived several hours before the storm surge. A sample of Mississippi and Louisiana tide gauges are shown in Figures 3.21-3.24, indicating that winds greater than 39 mph, and approaching hurricane strength, arrived between 4 and 8 hours before surge values of 6-10 feet occurred, typically less than would flood most homes.

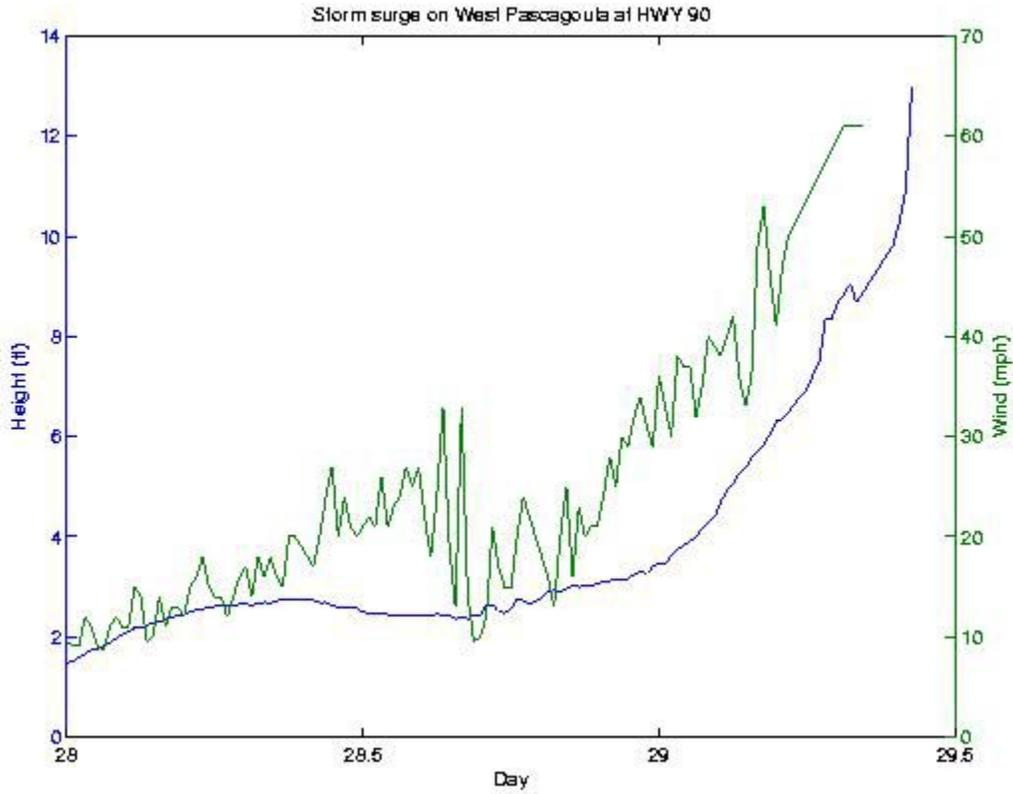

Figure 3.21. Times series plot surge and wind from tide gauge in West Pascagoula, MS, at HWY 90, before equipment failure.

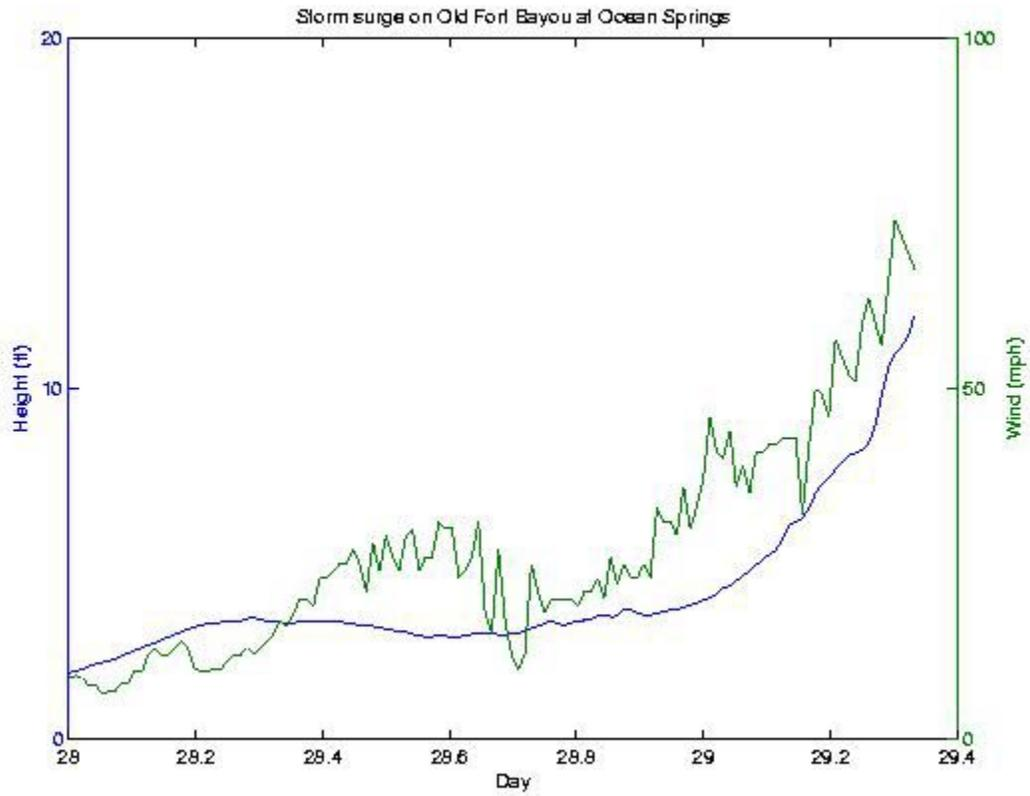

Figure 3.22. As in Figure 3.21, but for Old Fort Bayou at Ocean Springs.

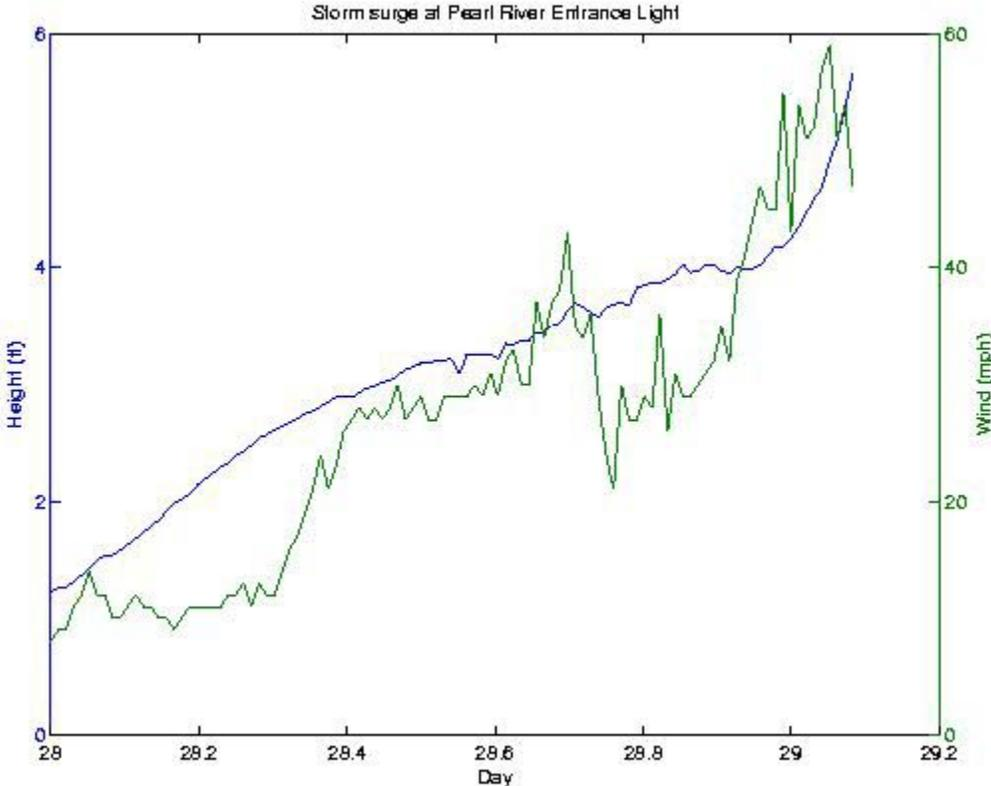

Figure 3.23. As in Figure 3.21, but for Pearl River Entrance Light.

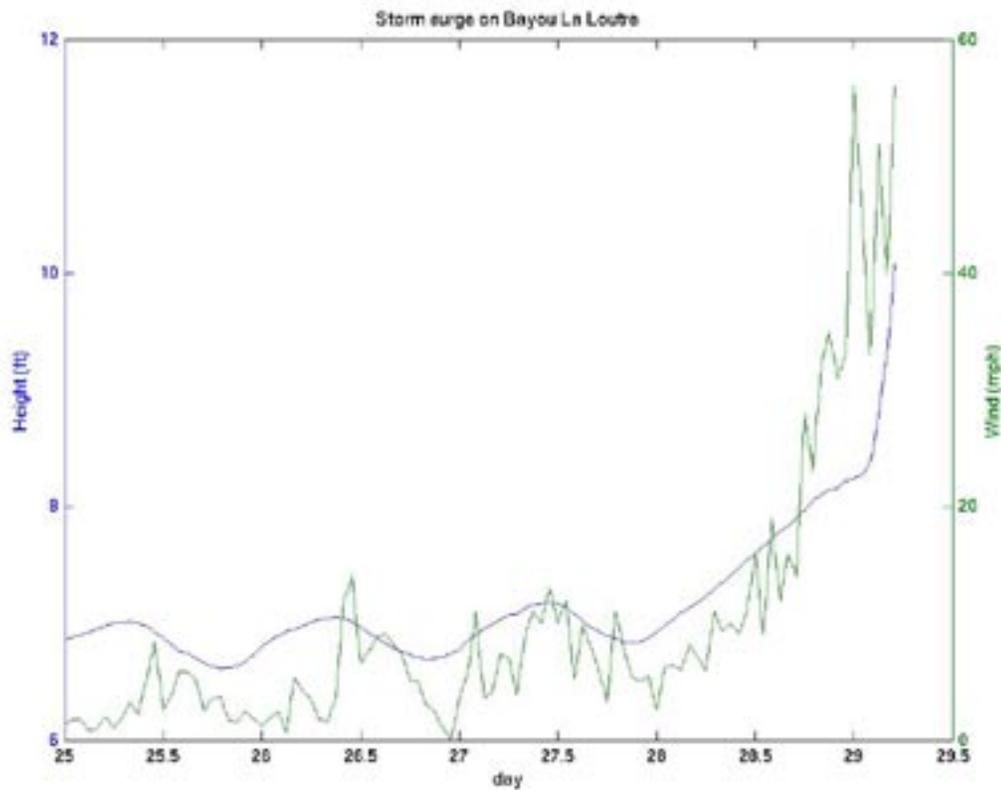

Figure 3.24. As in Figure 3.21, but for Bayou Loutre, LA. (Note that this plot starts August 25, while the others start August 28.)

Unfortunately, all tide gauges on the immediate coastline east of the mouth of the Mississippi River failed as hurricane-force winds arrived. Eyewitness accounts suggest hurricane-force winds preceded flooding of homes elevated above 10 feet by a short period of time. Because of instrument failure, the best way to investigate this matter is to use storm surge computer models. Times series plots along the beach of Bay St. Louis, Biloxi, and Ocean Springs, MS are shown in Figures 3.25-3.27 from 5AM to 1PM. At 5AM, while surge values are increasing, generally they are not enough to submerge buildings yet. However, tropical storm to Category 1-force winds are already present. Furthermore, the peak wind generally precedes the peak surge values by one hour. The lag time is small, but physically consistent. The surge is primarily a wind-driven event. The lag seems to be larger near the eyewall, since water tends to pile up within the eyewall, rising rather dramatically as the eyewall passes by. The lag is also large in the Slidell region (Figure 3.28), where Lake Pontchartrain is experiencing a sloshing effect due to the sudden wind shift.

**Hurricane Katrina (Adcirc Simulation)**

**TimeSeries for August 29th 10Z through 18Z**

**Lon=-89.195, Lat=30.18  
Bay\_St.Louis (West\_Gulf)**

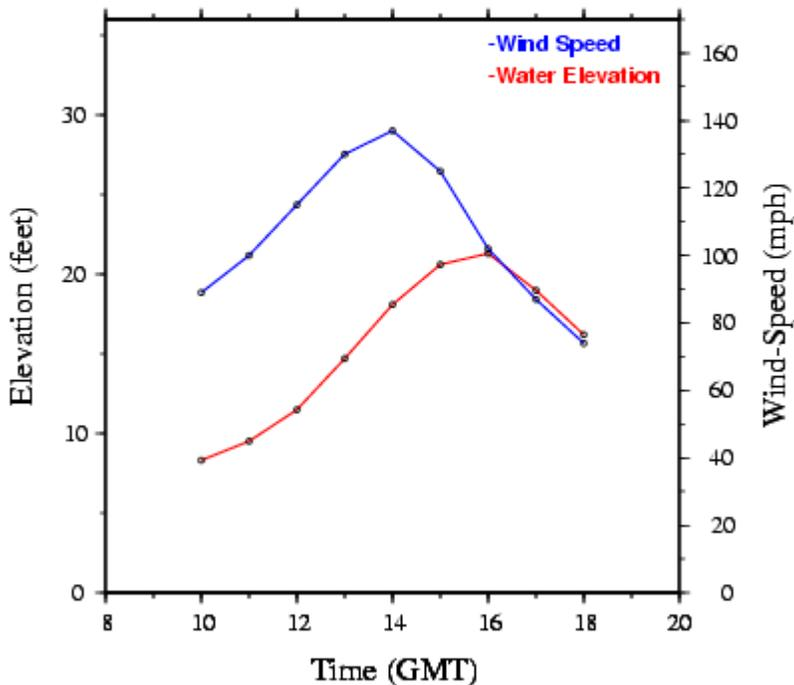

Product of Mississippi State University, GeoResources Institute, Stennis Space Center.

Figure 3.25. ADCIRC computer simulation time series of wind and storm surge for Bay St. Louis, MS, for hurricane-force wind conditions.

**Hurricane Katrina (Adcirc Simulation)**

**TimeSeries for August 29th 10Z through 18Z**

**Lon=-88.530, Lat=30.23**

**Biloxi (On\_Gulf)**

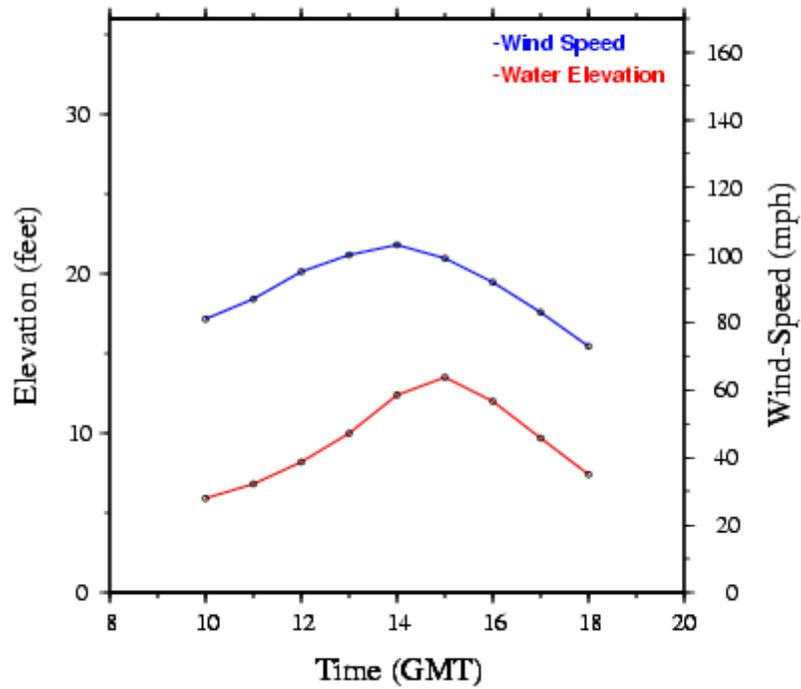

Product of Mississippi State University, GeoResources Institute, Stennis Space Center.

Figure 3.26. As in Figure 3.25, but for Biloxi, MS.

**Hurricane Katrina (Adcirc Simulation)**  
**TimeSeries for August 29th 10Z through 18Z**

**Lon=-88.50, Lat=30.24**  
**OceanSprings (On\_Gulf)**

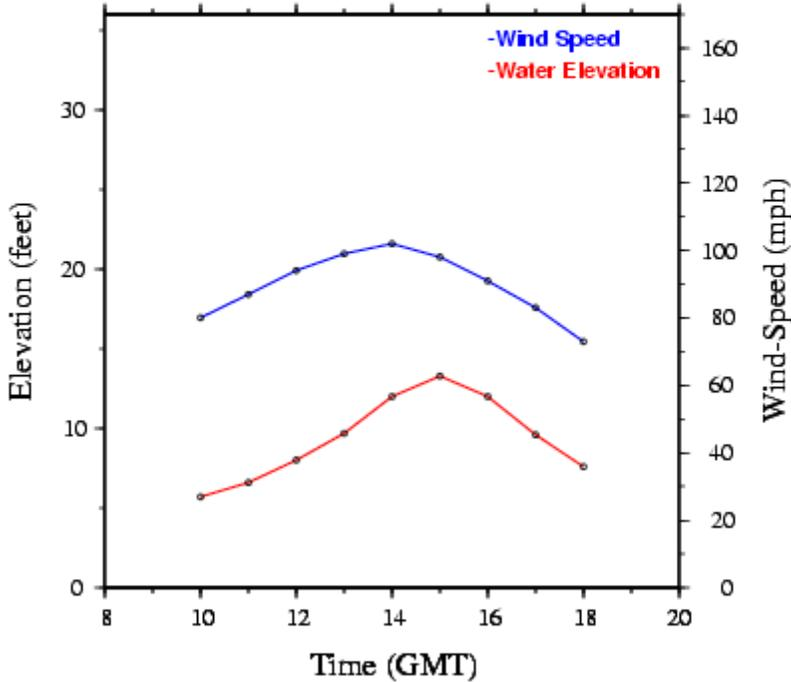

Product of Mississippi State University, GeoResources Institute, Stennis Space Center.

Figure 3.27. As in Figure 3.25, but for Ocean Springs, MS.

**Hurricane Katrina (Adcirc Simulation)**

**TimeSeries for August 29th 10Z through 18Z**

**Lon=-89.485, Lat=30.15**

**Slidell (On\_Lake)**

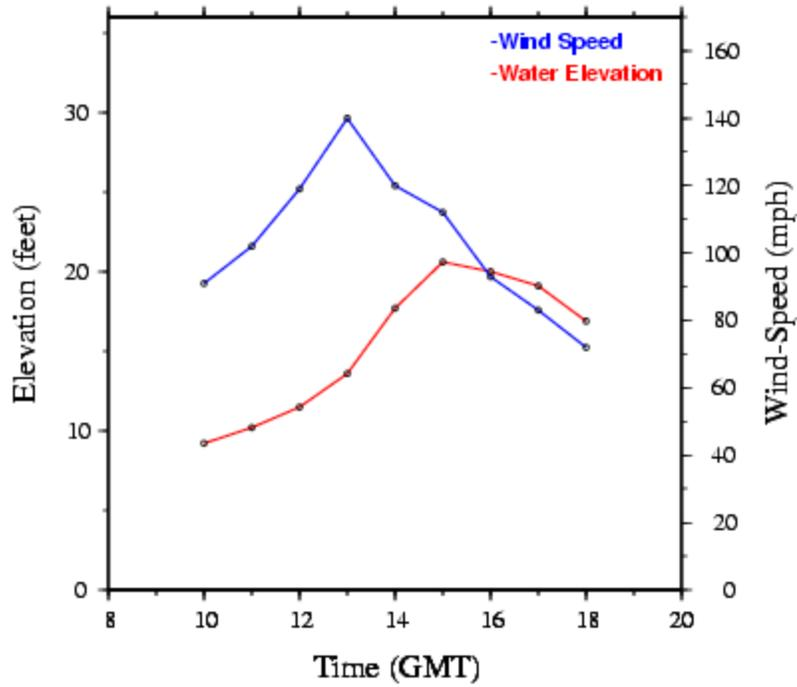

Product of Mississippi State University, GeoResources Institute, Stennis Space Center.

Figure 3.28. As in Figure 3.25, but for Slidell, LA

## **CHAPTER 4**

### **BUILDING PERFORMANCE**

Christopher D. Eamon, PhD, PE  
Assistant Professor of Civil Engineering  
Department of Civil Engineering  
Bagley College of Engineering  
Mississippi State University

#### **General**

There are a variety of extreme loads imposed on structures by a hurricane. In initial stages of the hurricane, wind and wave action raise the water surface substantially, resulting in a storm surge. As a result, walls of shoreline structures are subjected to a lateral hydrostatic as well as buoyancy loads. Wind driven waves associated with the raised water level during the storm surge impact structures and cause significant structural damage. This wave action is perhaps the most severe structural load during the storm, and is believed to be the cause of most of the damage shown in the figures contained in this report. The high winds accompanying the hurricane primarily damage roofs and exterior structural components, but pose much less of a threat to structures than the storm surge and wave action, which are severe enough in many cases to destroy entire structural systems. Additional associated loads include impact from water-borne and air-borne debris. Foundation erosion may also pose significant risks to structural stability.

#### **Summary of Severe Structural Damage Observations**

The following observations are drawn from a site visit of the Gulf Coast along Highway 90 from Biloxi, MS to Waveland, MS, on October 30-31, 2005 (Figure 4.1). All cities along this route were surveyed, including Waveland, Pass Christian, Long Beach, Gulfport, and Biloxi.

Three general types of construction were surveyed: commercial buildings, residential (apartment buildings and single-family homes), and selected infrastructure (bridges).

Many (most, if not all in some areas) wood houses along the coastline were completely destroyed. Residences further back from the coastline sustained less serious, if little apparent structural damage. It appears the first row of structures and trees along the coastline absorbed much of the storm surge energy.

Reinforced concrete and steel commercial structural frames in general performed well, suffering little visible damage, even on the coastline. However, building facades and infill walls did not perform well for buildings of any type. In general, commercial structural frames survived but building envelopes and interior walls were typically missing for the first few floors. This indicates surging water was the primary cause of

## FINAL REVIEW

failure for coastline buildings rather than wind (wind speed is typically greater at higher floor levels.)

Connections were the weak links in all types of buildings. Most commercial grade and light-frame wood house failures appeared to be due to weak connections rather than the failure of structural members and components.

### Infrastructure

#### Biloxi Bay Bridge

The Biloxi Bay Bridge is a 1.5 mile, 4-lane prestressed concrete highway bridge on US 90 that connects Biloxi to Ocean Springs. All spans of the bridge superstructure (deck and girders) appeared to have been raised and pushed in the northeast direction, typically dropping to the south side of the superstructure from the supporting piers (Fig 4.2.)

The piers appear undamaged, and many of the spans are not damaged severely. It appears that the bridge bearing was not constrained (Fig 4.3), and the water surge simply lifted the spans. Thus connection inadequacy is the believed cause of failure. Damage to the bridge spans was probably not directly from a water load but from the spans striking the piers and waterbed.

The water surge also caused significant scour beneath the roadway adjacent to the abutments as well as the abutments themselves (Fig 4.4.)

#### Bay St. Louis Bridge

The Bay St. Louis Bridge is a 2-mile, 4-lane prestressed concrete bridge spanning from Pass Christian to Bay St. Louis. This bridge lost all spans (Fig. 4.5.) There is some pier damage as well. As the visible spans appear intact, inadequate support constraint is the likely cause of failure, as with the Biloxi Bridge (Fig 4.6.) Serious scour was also observed along abutments here as well (Fig 4.7.)

### Reinforced Concrete Structures

Nearly all reinforced concrete (RC) structural frames observed appear to have survived well, with no apparent damage or cracks. However, façade and interior walls were often missing or significantly damaged (examples shown in Figs 4.8-4.11). An exception is a structure with the frame as well as walls constructed of RC (Fig 4.12.)

Multistory RC buildings on the coast often had contents of the first one or two floors missing but the upper floors appeared to have little to no damage. Figure 4.13 represents a typical structure of this type. Failure of the first or second floor façade may have been beneficial. If the façade and interior walls had the strength to resist failure, the resulting water pressure may have overloaded the structural frame.

One of the few observed RC failures was the collapse of columns holding what may have been a pergola roof. These columns failed at the base, a failure which may have been partially prevented if shear reinforcement were placed in the columns to increase confinement (Fig 4.14).

A RC building that appears to have been struck by a casino barge washed ashore fared well, where only the (apparently) struck corner was damaged but the remainder of the structure was unaffected (Fig 4.15). The local damage appears to have been well-contained and did not propagate to additional structural members.

### **Precast Concrete Structures**

Many precast concrete (PC) buildings observed sustained significant structural damage. The members themselves appear to have sufficient capacity. All observed failures occurred at the connections. Figure 4.16 shows an RC frame upon which PC floor slabs were placed. Although the RC frame was undamaged, the PC slabs appeared to have detached at the connections and slid to the northwest.

Figure 4.17 shows a collapsed structure composed of PC girders placed on top of columns. This structure supported a wood superstructure. Here again the PC members were undamaged but failed at the bolted connections. Views of the failed connection is shown in Figs. 4.18 and 4.19.

A PC pedestrian bridge also failed at the connections (Fig. 4.20). Here both girders were detached from the supporting column, and the deck detached from the girders, with the steel connectors still visible on top of the girders.

The second floor of a PC parking structure failed (Fig. 4.21) when the deck T-sections were pulled from their supports on the spandrel beam. Some spandrel beams supporting the second floor also collapsed (Fig. 4.22). Here again the primary cause of failure appears to be a lack of sufficient connection strength rather than member capacity.

### **Steel Frame Structures**

Most steel frames appeared to have survived intact, with little or no damage. As with the RC structures, this does not include the façade and interior walls, whether made of wood or steel studs (Figs. 4.23-4.29). There were some exceptions, however (Figs 4.45-4.48). Open web steel joist construction did not appear to perform as well as wide-flange steel frame construction (Figs. 4.30-4.31). The steel structures that failed appeared to have done so by buckling or other instabilities due to insufficient stiffness rather than member yielding. Comparable RC structural members, that typically have a greater stiffness for equivalent strength, did not seem to exhibit this type of failure.

### Wood Structures

Light-frame wood structures on the coastline were almost entirely destroyed. The remains of a typical coastline residence is shown in Fig 4.32, where sub-structural columns (often made of heavy-timber or RC) survived but the supported house did not. Primary failures were at the connections as a search of debris piles revealed most wood members intact.

For structures that did not collapse, common damage was:

1. Roof failures (Figs 4.33-4.34), which generally occurred away from the coastline, where the water surge was not great enough to topple the structure. These types of failures are due to wind damage. Notice that roof failures typically occur near the edges rather than central portion of the roof. Uplift forces are highest at these locations. For the most part, wood sheathing panels remained intact but lifted from the roof, indicating a lack of connection strength rather than member capacity. Higher winds produced more extensive damage to the roof structure itself (Fig 4.34.)
2. Siding failures (common on steel frame and RC frame buildings as well). Siding stripped from the structure is primarily a sign of wind damage (Fig 4.35), though more extensive damage to sheathing may indicate high water loads. Again, most losses of siding are indicative of insufficient fastener strength.
3. Side-sway failures, as shown in Fig 4.36. These were much less common than the types above, and represent a loss of lateral stability. This could either be induced by a wind or water pressure overload.

Heavy timber construction appeared to fare as well as steel and RC. In this type of construction, the connections (typically bolted) and member stiffnesses are much greater than those associated with the dimensional lumber in light-frame construction. Timber structural systems that survived include post-and-beam pier systems to support a light-frame structure above (Figs 4.37-4.38), docks (Fig. 4.39), and commercial-grade glued-laminated frames (Fig. 4.40). It is unknown if increasing the strength of connections alone would have prevented the failure of wood structures.

### Facades and Non-Structural Walls

As noted earlier, facades and non-structural interior walls of all types did not perform well during the hurricane. For those building floors subjected to the storm surge, there appears to be little difference among the performance of CMU walls, brick masonry, wood or steel stud.

### Stay In-Place (SIP) Reinforced-Concrete Construction

There are various SIP (not equivalent to structural insulated panel, also abbreviated SIP)

**FINAL REVIEW**

technologies available. Typically, two thin, rigid exterior panels are linked together with ties or metal studs. These panels act as formwork for a site-poured, reinforced-concrete (RC) wall. Exterior panels may be composed of a number of different synthetic materials, including rigid foam, polyvinyl chloride, steel, or composite materials. The concrete walls are typically thinner than in typical RC or concrete-masonry unit wall construction, often approximately 4” thick. The type of construction referenced in this report is similar and has rigid foam exterior walls (Fig. 4.41). Many SIP structures observed performed well, particularly compared to wood residential construction. Figures 4.42-4.43 show SIP houses paired with wood roofs. In these cases, the wood roofs were damaged but the SIP walls were relatively unharmed. However, as shown in Fig 4.41, a significant number of SIP walls also failed. In Figure 4.43, a SIP house appears in the foreground while a severely damaged wood house is in the background. As shown in Fig 4.44, some SIP buildings performed similar to steel or RC frames, where non-structural components such as doors, windows, and interior partitions were destroyed, but the structure itself performed well. Figure 4.45 shows a surviving SIP-walled structure with a destroyed wood floor.



Figure 4.1 Extent of Survey



Figure 4.2 Biloxi Bay Bridge



Figure 4.3 Biloxi Bay Bridge Bearings



Figure 4.4. Biloxi Bay Bridge Road Undermining



Figure 4.5 Pier Damage to Bay St. Louis Bridge



Figure 4.6 Bay St. Louis Bridge Bearings



Figure 4.7 Bay St. Louis Bridge Abutment Scour



Figure 4.8 Survived RC Structural Frame



Figure 4.9 Survived RC Structural Frame that Supported Wood Superstructure



Figure 4.10 Close-Up of RC Structural Frame in Fig 4.12. Note no visible cracks or any other apparent structural damage.



Figure 4.11 Survived RC Frame



Figure 4.12. Survived RC Frame and Exterior Wall Structure.



Figure 4.13 Survived RC Frame Structure



Figure 4.14 RC Failed Columns



Figure 4.15. RC Frame Building Struck By Casio Boat



Figure 4.16. Failed PC Slabs Supported by RC Frame



Figure 4.17. Failed PC Girder System



Figure 4.18. Failed PC Column Connection



Figure 4.19. Failed PC Girder Connection



Figure 4.20. Failed PC Pedestrian Bridge



Figure 4.21. Failed PC Parking Structure



Figure 4.22. Failed PC Parking Structure



Figure 4.23 Survived Steel Frame



Figure 4.24 Survived Steel Frame



Figure 4.25 Survived Steel Frame



Figure 4.26 Survived Steel Frame



Figure 4.27 Survived Steel Frame



Figure 4.28 Survived Steel Frame



Figure 4.29 Survived Steel Frame



Figure 4.30 Failed Steel Frame



Figure 4.31 Failed Steel Frame with Open-Web Joist Roof



Figure 4.32 Typical Remains of Wood Structure--Superstructure Completely Destroyed



Figure 4.33 Roof Failure on Wood House



Figure 4.34 Roof Structural Failure on Wood Building



Figure 4.35 Siding Damage on Wood Building



Figure 4.36 Side-Sway Failure in Wood House



Figure 4.37. Survived Wood Pier System



Figure 4.38. Survived Wood Pier System



Figure 4.39. Survived Wood Doc



Figure 4.40. Survived Wood Glued-Laminated Structural Frame



Figure 4.41. SIP Wall Construction



Figure 4.42. Survived SIP House with Wood Roof Damage



Figure 4.43. Survived SIP House, Severely Damaged Wood House in Background



Figure 4.44. Survived SIP Structure



Figure 4.45. Survived SIP Structure with Destroyed Wood Floor

## **CHAPTER 5**

### **DESIGN OPTIONS**

Christopher D. Eamon, PhD, PE  
Assistant Professor of Civil Engineering  
Department of Civil Engineering  
Bagley College of Engineering  
Mississippi State University

#### **General**

Although Katrina caused significant economic damage from high winds, the extent of wind damage to a typical coastal structure was much less severe than that caused by storm surge. For wind, damage was usually localized to roofing panels, while for storm surge, entire structures were destroyed. Thus, minor revision of current roof standards and then rigorous enforcement would be beneficial. However, there is need to examine land use planning and design for storm surge loading.

#### **Design Options**

Options to address issues range from do nothing to comprehensive land use planning and design for potential hurricane loadings. Possible options include:

1. *Allow no construction for human habitation in high-risk flood areas.* Land in this area could be converted to public beach or parkland. Removing structures from the path of the most severe loads is the easiest structural solution. This consequence has economic, social and political consequences.
2. *Rebuild existing structures without significant revision to construction standards.* The expectation would be that a similar amount of damage would occur in the future from a hurricane with a magnitude close to that of Katrina. In the short term, this may be the cheapest solution. In the long term, the economic loss resulting from structural damage, disruption of the transportation infrastructure, curtailing of business transactions, and environmental damage, among other effects, may be severe. A less quantifiable but significant issue is the potential loss of life.
3. *Rebuild structures on-grade that can sustain storm surge loads.* This may be feasible for commercial buildings, particularly those of reinforced concrete. Façade walls on the first two or three floors would become structural, and designed to resist storm surge load. Reinforced concrete or heavily reinforced CMU walls integrally connected to the structural frame would be necessary. Drawbacks include a need to temporarily harden wall openings such as windows and doors, and obtaining a reasonable estimate of the load caused by storm surge. Strengthening of the structural frame may also be necessary. Not allowing the façade to break away, as what typically occurred during Katrina, would

## FINAL REVIEW

impose significant additional loads on the structure, which would have to carry the load of water pressure on the façade. This approach may be prohibitively expensive for single-family houses.

*4. Keep a similar design flood elevation (DFE) and strengthen upper floors as needed.*

Here everything below the DFE would be expected to flood. Space below the DFE would be sacrificial: parking or storage, for example. If enclosed, this space would require ‘break-away’ walls that would allow water to flow freely and not overload the structural frame from storm surge pressure.

*5. Raise the design flood elevation.* This may be the easiest option to implement.

However, there may be significant drawbacks. Primarily, there is a need to move people from the ground to a habitable floor elevation. Commercial buildings would require elevators. For private residences, the costs involved for mechanical lifts are likely prohibitive. Long stairways become impractical and undesirable. Increasing height will also add to structural cost.

*6. Develop a safe room for storm surge.* Several agencies are currently studying development of a small room within a larger structure (such as a house) that is meant to withstand hurricane or tornado-force winds and debris impact. The understanding is that the larger structure is sacrificial under an extreme load, but the smaller room is designed to survive, allowing occupants a safe space to occupy. This concept may be carried over to storm surge loads as well.

*7. Erect barriers to absorb storm surge energy.* A barrier of sacrificial or permanent construction could be erected between the coastline and the structures to block the storm surge. For such a barrier to be effective, however, it would likely result in blocking views to the gulf.

*8. Combine various options.* The most feasible and desirable solution may be a combination of options. For example, raising the DFE but only slightly (as per 5), and strengthening upper floors as needed, with the assumption that lower floors are sacrificial (as per 4).

### Criteria Development

For changes to be implemented effectively, particularly those that involve strengthening structures or changing the DFE for future storm surge loads, hurricane load information must be gathered. Specifically, the statistical parameters (for example, mean value, coefficient of variation, and distribution) associated with primary storm surge loads are needed. This information is critical to accurately design for load effects, and in particular, those with high variation such as found from hurricanes. Most current civil engineering standards (AASHTO, AISC, ACI 318) have recognized the need for a probabilistic approach and have developed a reliability-based load and resistance factor (LRFD) format. Unfortunately there is a significant lack of storm surge load

## **FINAL REVIEW**

information in ASCE 24. This is understandable, as extreme events are rare and more rarely rigorously monitored for load information. Without this information, there can be no quantifiable indication of what level of safety, or failure probability, a particular design change will provide. This renders proposed changes arbitrary and uncertain.

**CHAPTER 6**

**BUILDING CODE REVIEW**

Christopher D. Eamon, PhD, PE  
Assistant Professor of Civil Engineering

And

Phillip M. Gullett, PhD  
Assistant Professor of Civil Engineering  
Department of Civil Engineering  
Bagley College of Engineering  
Mississippi State University

**General**

In the aftermath of Hurricane Katrina there was greater emphasis on performance of construction along the Mississippi Gulf Coast subject to storm surge and wind loads. Part of the focus was related to the specific need for enhanced building codes on the coast as well as state wide. A study was made of the background and features of building codes proposed for adoption.

**Codes and Standards**

Various building codes are available in the US, the most common of which are given in Table 6.1. Historically, the Standard Building Code (SBC) was used in the Southeastern US. After Hurricane Katrina, Louisiana adopted the International Building Code (IBC) statewide. Mississippi currently has no statewide code, but local communities along the coastline have either adopted (such as Pass Christian) or are considering adopting (such as Gulfport) the IBC. Florida has its own statewide code, which closely follows the IBC. In general, these codes are prescriptive, specifying minimum design loads as well as minimum specific construction practices (such as nail schedules, sheathing thicknesses, etc.) in some cases.

Table 6.1. Common Building Codes in US

Code	Current Publication Date	Sponsoring Organization
International Building Code (IBC)	2003	International Code Council (ICC)
International Residential Code	2003	ICC
BOCA National Building Code	1999	Building Officials and Code Administrators (BOCA)
Standard Building Code (SBC)	1999	Southern Building Code Congress International (SBCCI)
Uniform Building Code (UBC)	1997	International Conference of Building Officials (ICBO)

## FINAL REVIEW

In addition, there are several design guidelines and standards (also commonly referred to as ‘codes’) published by professional organizations in the civil engineering community that describe design loads as well as analysis methods that may be used to determine load effects and structural resistances. Some of these are given in Table 6.2. These publications will be referred to as ‘standards’ in this report. These standards are frequently referenced in the building codes in Table 6.1 above.

Table 6.2 Common Civil Engineering Design Standards

Design Guide	Area of Application	Current Publication Date*	Sponsoring Organization
Standard Specifications for Highway Bridges	Bridges	2002	American Association of State and Highway Transportation Officials (AASHTO)
LRFD Bridge Design Specifications	Bridges	2004	AASHTO
Manual of Steel Construction, LRFD	Steel structures	2001	American Institute of Steel Construction (AISC)
Steel Construction Manual, ASD	Steel structures	1989	AISC
Steel Construction Manual-- ASD/LRFD	Steel Structures	2005	AISC
ACI 318 Building Code and Commentary	Concrete Structures	2005	American Concrete Institute (ACI)
ACI 530 Building Code Requirements for Masonry Structures	Masonry Structures	2005	ACI
National Design Specification for Wood Construction (NDS)	Wood Structures	2005	American Forest and Paper Association
LRFD Manual for Engineered Wood Construction	Wood Structures	2005	American Forest and Paper Association
ASCE Standard 7 Minimum Design Loads for Buildings and Other Structures	General Structural Loads	2005	American Society of Civil Engineers (ASCE)
ASCE 24: Flood Resistant Design and Construction	Storm Surge Structural Loads	2005	ASCE

\*Some have intermediate, partial updates which may supercede listed date.

## FINAL REVIEW

In 2000, the International Code Council (ICC) developed the International Building Code (IBC), in conjunction with the three statutory members of the ICC (the Building Officials and Code Administrators, BOCA; The International Conference of Building Officials, ICBO; and the Southern Building Code Congress International (SBCCI). See appendix for a history of the International Codes and their implications on design and construction in Mississippi. The IBC is intended to incorporate and supercede these previous codes into a single consistent set of regulations. The IBC is intended to be updated every three years, while the contributing codes (BOCA, ICBO, SBC) are no longer being updated. Current building code specifications relevant to wind and storm surge loads and resistances are summarized below. Relevant ASCE 7 standards and IBC specifications are briefly presented, while only significant differences in other codes are mentioned.

### **2003 International Building Code (IBC)**

#### General Loads

Either allowable stress design (ASD) or load and resistance factor design (LRFD) is permitted.

The former is the traditional method of engineering design and involves summing up the loads from various sources (dead load, live load, wind load, etc.) and applying a safety factor to the total load effect or to material resistance. The LRFD method, which was developed in the last two decades, involves applying different ‘safety factors’ to each load effect and material resistance individually. These factors have been probabilistically calibrated such that the reliability of LRFD-designed structures is more consistent than those designed with the ASD method. However, in both methods probability of occurrence of various load combinations are considered for design. These are given in Section 1605, and are taken unchanged from ASCE 7 section 2.3. The IBC also allows use of an alternative set of load combinations, as specified in 1605.3.2.

#### Wind Loads

IBC Section 1609 specifies that ASCE 7 wind loads are to be considered for design. However, there is an exception. For buildings located within Exposure B or C and not sited on the upper half of an isolated hill, ridge or escarpment, the provisions of SBCCI SSTD 10 Standard for Hurricane Resistant Residential Construction is allowed for applicable Group R2 and R3 buildings, and residential structures using the provisions of the AF&PA Wood Frame Construction Manual for One- and Two-Family Dwellings are allowed. Also, a minimum wind load used in the design of the main wind-force-resisting system is specified as 10psf

#### Rain Loads

Section 16.11.1 Specifies that roofs must be designed assuming the primary drainage system for the roof is blocked.

### Flood Loads

Section 1612.4 specifies that buildings located in flood hazard areas are to be designed in accordance with ASCE 24.

### Resistance

Resistance is specified in two ways. First, the analysis of component resistance is governed by reference to the standards in Table 6.2. This includes strength as well as serviceability (deflection) limits, as referenced in section 1604.3. A set of deflection limits is also given in Table 1604.3. Second, resistance is specified prescriptively, via minimum structural properties, such as fastener schedules, sheathing thicknesses, etc.)

### Roofs

Section 1507 describes the requirements for a variety of roof types, including asphalt shingles, clay tile, metal roof panels, wood shingles, built-up roofs, and others. The code requires that roof coverings follow the provisions of the IBC as well as manufacturer's installation instructions.

Table 1507.2 summarizes requirements for asphalt shingles, including minimum fastening, underlayment, and roof slope. Specific rules for shingle fasteners are specified in section 1507.2.6-8. Special provisions exist for underlayment in high wind areas, as detailed in section 1507.2.8. Section 1507.4.4 describes attachment requirements for metal roofs. Several fastener options are specified in lieu of manufacturer's recommendations. Section 1507.10 describes built-up roof requirements, while Table 1507.10.2 details material standards.

### Anchorage

Section 1604.8 specifies anchorage requirements. Anchorage of roofs, walls, and columns must be sufficient to prevent uplift and sliding. Section 1604.8.2 gives specific resistance requirements for concrete and masonry walls.

### **2003 International Residential Code (IRC)**

The IRC is primarily prescriptive, specifying minimum construction standards for materials and fasteners, rather than loads. Two sections are particularly relevant here: Chapter 6, Wall Construction, and Chapter 8, Roof-Ceiling Construction.

### **2003 Florida Building (FBC) and Residential Codes (FRC)**

These codes are closely modeled after the 2003 IBC and IRC, with few differences. Wind loads are specified to be taken from ASCE 7.

**FINAL REVIEW**

The FBC adds a section 1620, High-Velocity Hurricane Zones. Here all buildings are specified to be considered in Exposure category C (section 1620.3). Explicit wind velocities are given for Broward County (140 mph) and Miami-Dade County (146 mph).

The FRC adds a Chapter 44 in Section IX Referenced Standards: High-Velocity Hurricane Zones. Buildings within this zone are to follow the specifications in Chapter 44. Much of this chapter is administrative in nature. Other portions specify construction practices with regard to durability and weather-ability, but in general are not structural. Much is taken from the FBC.

**1999 BOCA National Building Code**

Wind Loads

Section 1609.1 states that ASCE 7 loads and load combinations are to be used for design. However, slight differences exist between ASCE 7 wind load importance factors and those specified by BOCA. These are given in Table 7.3 below, with ASCE 7 values for equivalent category buildings included in parenthesis if different. In general, BOCA values appear more conservative than ASCE 7.

Table 6.3. Wind Load Importance Factors in BOCA

Nature of occupancy	BOCA Wind Load Importance Factor (ASCE 7 factor)	
	100 miles from hurricane ocean line, and in other areas	At hurricane ocean line
All buildings and structures except those listed below	1.00	1.10 (1.0)
300 or more people	1.15	1.23 (1.15)
Emergency etc	1.15	1.23 (1.15)
Low hazard	0.90 (0.87)	1.00 (0.77)

**1999 Standard Building Code (SBC)**

General Loads

SBC section 1601.2.2 states that use of ASCE 7 loads is acceptable. Several alternatives are available as well for specific buildings, as discussed below.

Wind Loads

Section 1606 requires use of ASCE 7 for determination of wind forces on structures, with exceptions for:

1. Buildings 60 ft. high or less may use the provisions of SBC section 1606.2
2. Wind tunnel tests together with applicable sections of 1606.2

## FINAL REVIEW

3. Group R2 and R3 buildings may use SBCCI SSTD 10
4. Group R3 wood framed buildings may use the provisions of AF&PA Wood Frame Construction Manual for One and Two-Family Dwellings – 1995 SBC High Wind Edition 1996.

Section 1606.2 provides a simplified computation of wind pressures for relatively low exposure structures. Computation of wind pressures involves determination of velocity pressure(s), velocity coefficient and use factor. ASCE requires a more detailed evaluation based on exposure category, topographic factor, gust factor, enclosure classification, internal pressure coefficient, and external pressure coefficient.

### Load Combinations

Section 1609 gives provisions for differing combinations of loads. Structures must resist the most critical effects resulting from the following combinations of loads:

$$D + L + (L_r \text{ or } S) \quad (6.1)$$

$$D + L + (W \text{ or } E/1.4) \quad (6.2)$$

$$D + L + W \text{ or } S/2 \quad (6.3)$$

$$D + L + W/2 \text{ or } S \quad (6.4)$$

$$D + L + S + E/1.4 \quad (6.5)$$

Where:

D = dead load

E = earthquake

L = live load

$L_r$  = roof live load

S = snow load

W = wind load

Appendix J, Special Requirements for Buildings Constructed in Hurricane-Prone Regions, specifies requirements for protection of glazed openings against windborne debris. Section 1608 lists the requirements for special loads, though there are no special provisions for roof loads.

1997 Uniform Building Code (UBC)

### General Loads

Section 1604 of UBC lists ASCE 7 as the recognized standard for minimum design loads for buildings and other structures. Load Combinations Using Strength Design or Load and Resistance Factor Design are detailed in Section 1612.2.1 and are the same as those specified in 2003 IBC. Section 1612.3.1 provides the following load combinations when

## FINAL REVIEW

allowable stress design is used:

$$D \quad (6.6)$$

$$D + L + (L_r \text{ or } S) \quad (6.7)$$

$$D + (W \text{ or } E/1.4) \quad (6.8)$$

$$0.9D \pm E/1.4 \quad (6.9)$$

$$D + 0.75[L + (L_r \text{ or } S) + (W \text{ or } E/1.4)] \quad (6.10)$$

Section 1612.3.2 specifies another set of load combinations. For this set, a one-third increase is permitted in allowable stress for all combinations including W or E.

$$D + L + (L_r \text{ or } S) \quad (6.11)$$

$$D + L + (W \text{ or } E/1.4) \quad (6.12)$$

$$D + L + W + S/2 \quad (6.13)$$

$$D + L + S + W/2 \quad (6.14)$$

$$D + L + S + E/1.4 \quad (6.15)$$

$$0.9 D \pm E/1.4 \quad (6.16)$$

### Wind Loads

Division III-Wind Design provides guidance for determination of wind loads to be used in the design calculations. The application is restricted to buildings that are not sensitive to dynamic effects, and applies to building heights of up to 400 feet. Wind pressure is computed from a single equation

$$P = C_e C_q q_s I_w, \quad (6.17)$$

Where P is the design pressure,  $C_e$  is the combined height, exposure and gust coefficient,  $C_q$  is the pressure coefficient,  $q_s$  is the wind stagnation coefficient, and  $I_w$  is the structures importance factor. These values are given or can be calculated based on a procedure described in the UBC. The UBC method 2 provisions are similar to the provisions of ASCE 7 but are somewhat less complex due to ASCE 7's detailed evaluation based on exposure category, topographic factor, gust factor, enclosure classification, internal pressure coefficient, and external pressure coefficient.

Two methods are prescribed for application of wind pressure. Method 1, the Normal Force Method, accounts for wind forces with inward and outward forces acting normal to all exterior surfaces simultaneously. Method 2, the Projected Area Method, considers the application of horizontal pressures on the vertical projection of the building surface area and vertical pressure on the horizontal projected area. It is a simpler method, but may not be sufficiently accurate for gabled rigid frames and tall structures.

**2002 ASCE 7**

ASCE 7 specifies minimum design loads. As the IBC references ASCE 7 provisions, the wind load and flood load design procedures is summarized.

Load Combinations

Section 2.0 of ASCE 7 presents the load combinations to be considered in design. The basic load combinations for Load and Resistance Factor Design (LRFD) are given as:

1.  $1.4 (D + F)$  (6.18)
2.  $1.2(D+F+T) + 1.6(L+H) + 0.5(L_r \text{ or } S \text{ or } R)$  (6.19)
3.  $1.2D + 1.6(L_r \text{ or } S \text{ or } R) + (L \text{ or } 0.8W)$  (6.20)
4.  $1.2D + 1.6W + L + 0.5(L_r \text{ or } S \text{ or } R)$  (6.21)
5.  $1.2D + 1.0E + L + 0.2S$  (6.22)
6.  $0.9D + 1.6W + 1.6H$  (6.23)
7.  $0.9D + 1.0E + 1.6H$  (6.24)

For V-Zones or Coastal A-Zones (see the section in this report describing ASCE 24), 1.6W is replaced with  $1.6W + 2.0F_a$ . For noncoastal A-Zones, 1.6W is replaced with  $0.8W + 1.0F_a$ .

For load combinations 3, 4, and 5, the load factor L is taken as 0.5 for many common situations, as described in ASCE 7.

Where:

- D = dead load
- E = earthquake
- F = fluid pressure (not from flooding)
- F<sub>a</sub> = flood load
- H = lateral earth pressure
- L = live load
- L<sub>r</sub> = roof live load
- R = rain load
- S = snow load
- T = self-straining force (e.g. temperature effects)
- W = wind load

A similar set of load combinations for allowable stress design (ASD) is given in section 2.4.1.

Wind Loads

Wind loads are presented in Section 6.0. Two structural systems must be considered for design: 1) the Main Wind Force-Resisting System, and 2) Components and Cladding. The information below applies to both building systems. Three methods are presented in

ASCE 7 for load distribution:

1. Method 1: Simplified Procedure
2. Method 2: Analytical Procedure
3. Method 3: Wind-Tunnel Procedure

Method 1 is only applicable for buildings satisfying certain geometric and topographic properties as specified in sections 6.4.1.1 and 6.4.1.2. In general, these criteria can be summarized as applying to low-rise, regularly-shaped structures without a high roof pitch (less than 45 degrees), or peculiar geometric or structural characteristics. Most buildings would fall within these criteria. The IBC repeats the simplified procedure from ASCE 7 explicitly.

The Simplified method has three steps:

1. Determine the basic wind speed  $V$ . This is read from a wind speed contour map, as shown in Figs 6.1-6.2. The design wind pressure  $p_{30}$  is then read from a table (Figs. 6.3-6.4).
2. Determine the building importance factor  $I$ . Buildings that are associated with a higher probability of loss of human life upon failure are given higher importance factors. Most buildings fall within Category II, which results in an importance factor of 1.0.
3. Determine exposure category. This adjusts for terrain surrounding the building, to account for potential increases or decreases due to wind speed. Categories are from B (“urban and suburban areas, wooded areas or other terrain with numerous closely spaced obstructions...”) to D (“at, unobstructed areas and water surfaces outside hurricane prone regions.”) (ASCE 7).

To design the main wind force-resisting system, the building exterior is loaded in various zones with horizontal (zones A-D) or vertical (zones E-H) (Fig. 6.5) pressures,  $p_s$ , determined by multiplying the design wind pressure found from step 1 by the importance factor and an additional adjustment factor,  $\lambda$ , accounting for building height and exposure factor (Fig. 6.6):

$$p_s = \lambda I p_{30} \quad (6.25)$$

A minimum load effect is specified as the result from the case considering pressure  $p_s$  equal to +10 psf for zones A-D and 0 for zones E-H.

To design components and cladding, the same method is used but with a net pressure,  $p_{net}$ , given in Figs. 6.7-6.8 and zones defined as given in Figure 7.9. Here net pressure,  $p_{net}$ , is applied normal to the surface.

$$p_{net} = \lambda I p_{net} \quad (6.26)$$

## FINAL REVIEW

Minimum  $p_{net}$  pressures are specified as +/- 10 psf.

Method 2 is a more complicated procedure that applies to high-rise structures and a wider variety of roof configurations than that allowed in Method 1. It accounts for building resonance due to wind-induced vibrations. However, the building still must be regularly shaped and not have unusual wind response characteristics.

Method 3 may be used for all structures, particularly those that do not meet the restrictions of methods 1 or 2. It involves constructing a scale model and monitoring its performance in a wind tunnel test.

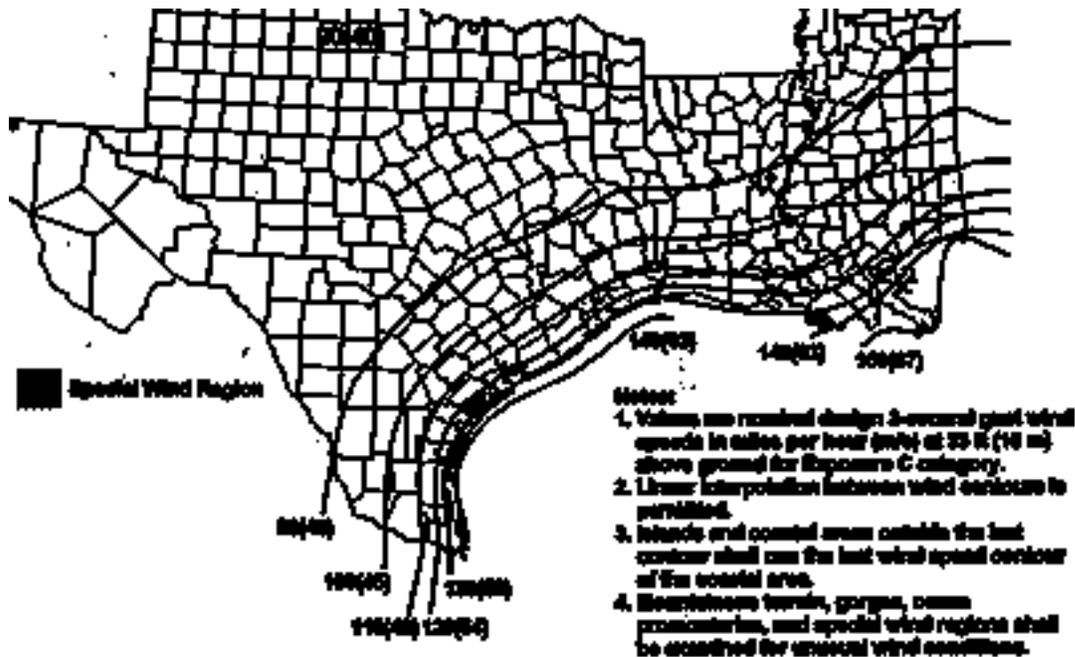

Figure 6.1 Wind Speed Map (With permission from ASCE).

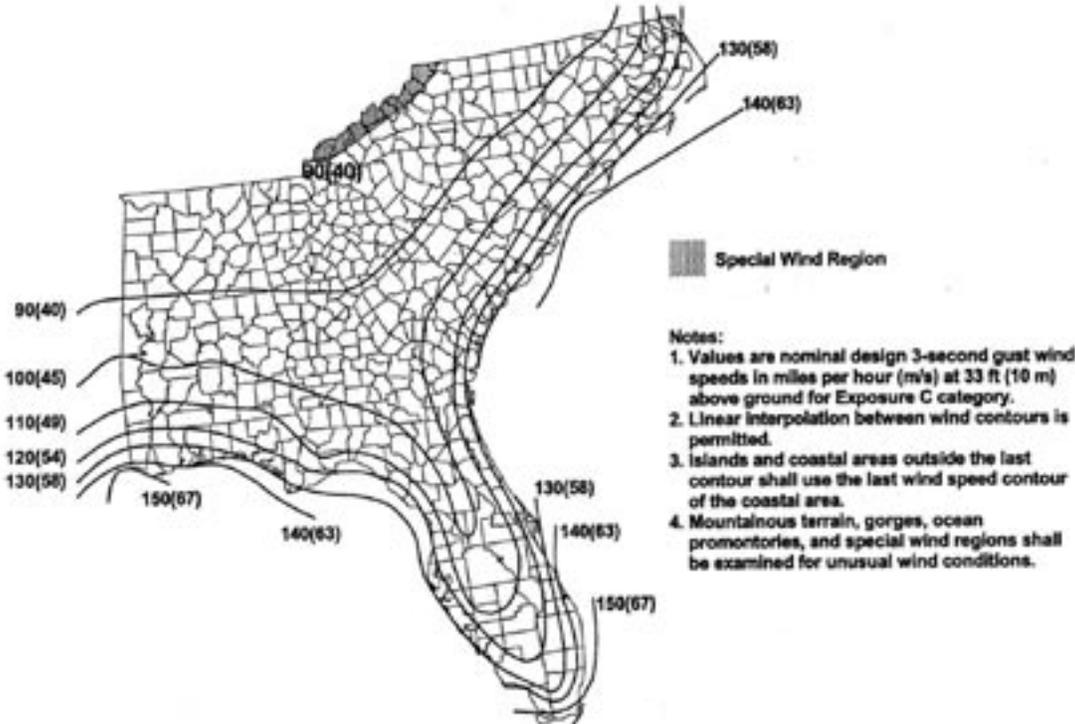

Figure 6.2 Wind Speed Map (With permission from ASCE)

FINAL REVIEW

Simplified Design Wind Pressure,  $P_{s30}$  (psf) (Exposure B at  $h = 30$  ft. with  $I = 1.0$ )

Basic Wind Speed (mph)	Roof Angle (degrees)	Load Case	Zones									
			Horizontal Pressures				Vertical Pressures				Overhangs	
			A	B	C	D	E	F	G	H	EoH	GoH
85	0 to 5°	1	11.5	-5.9	7.6	-3.5	-13.8	-7.8	-9.6	-6.1	-19.3	-15.1
	10°	1	12.9	-5.4	8.6	-3.1	-13.8	-8.4	-9.6	-6.5	-19.3	-15.1
	15°	1	14.4	-4.8	9.6	-2.7	-13.8	-9.0	-9.6	-6.9	-19.3	-15.1
	20°	1	15.9	-4.2	10.6	-2.3	-13.8	-9.6	-9.6	-7.3	-19.3	-15.1
	25°	1	14.4	2.3	10.4	2.4	-6.4	-8.7	-4.6	-7.0	-11.9	-10.1
		2	—	—	—	—	-2.4	-4.7	-0.7	-3.0	—	—
	30 to 45	1	12.9	8.8	10.2	7.0	1.0	-7.6	0.3	-6.7	-4.5	-5.2
		2	12.9	8.8	10.2	7.0	5.0	-3.9	4.3	-2.8	-4.5	-5.2
90	0 to 5°	1	12.8	-6.7	8.5	-4.0	-15.4	-8.8	-10.7	-6.8	-21.6	-16.9
	10°	1	14.5	-6.0	9.6	-3.5	-15.4	-9.4	-10.7	-7.2	-21.6	-16.9
	15°	1	16.1	-5.4	10.7	-3.0	-15.4	-10.1	-10.7	-7.7	-21.6	-16.9
	20°	1	17.8	-4.7	11.9	-2.6	-15.4	-10.7	-10.7	-8.1	-21.6	-16.9
	25°	1	16.1	2.6	11.7	2.7	-7.2	-9.8	-5.2	-7.8	-13.3	-11.4
		2	—	—	—	—	-2.7	-5.3	-0.7	-3.4	—	—
	30 to 45	1	14.4	9.9	11.5	7.9	1.1	-8.8	0.4	-7.5	-5.1	-5.8
		2	14.4	9.9	11.5	7.9	5.6	-4.3	4.8	-3.1	-5.1	-5.8
100	0 to 5°	1	15.9	-8.2	10.5	-4.9	-19.1	-10.8	-13.3	-8.4	-26.7	-20.9
	10°	1	17.9	-7.4	11.9	-4.3	-19.1	-11.6	-13.3	-8.9	-26.7	-20.9
	15°	1	19.9	-6.6	13.3	-3.8	-19.1	-12.4	-13.3	-9.5	-26.7	-20.9
	20°	1	22.0	-5.8	14.6	-3.2	-19.1	-13.3	-13.3	-10.1	-26.7	-20.9
	25°	1	19.9	3.2	14.4	3.3	-8.8	-12.0	-6.4	-9.7	-16.5	-14.0
		2	—	—	—	—	-3.4	-6.8	-0.9	-4.2	—	—
	30 to 45	1	17.8	12.2	14.2	9.8	1.4	-10.6	0.5	-9.3	-6.3	-7.2
		2	17.8	12.2	14.2	9.8	6.9	-5.3	5.9	-3.8	-6.3	-7.2
110	0 to 5°	1	19.2	-10.0	12.7	-5.9	-23.1	-13.1	-16.0	-10.1	-32.3	-25.3
	10°	1	21.6	-9.0	14.4	-5.2	-23.1	-14.1	-16.0	-10.8	-32.3	-25.3
	15°	1	24.1	-8.0	16.0	-4.6	-23.1	-15.1	-16.0	-11.5	-32.3	-25.3
	20°	1	26.6	-7.0	17.7	-3.9	-23.1	-16.0	-16.0	-12.2	-32.3	-25.3
	25°	1	24.1	3.9	17.4	4.0	-10.7	-14.6	-7.7	-11.7	-19.9	-17.0
		2	—	—	—	—	-4.1	-7.9	-1.1	-5.1	—	—
	30 to 45	1	21.6	14.8	17.2	11.8	1.7	-13.1	0.6	-11.3	-7.6	-8.7
		2	21.6	14.8	17.2	11.8	8.3	-6.5	7.2	-4.6	-7.6	-8.7
120	0 to 5°	1	22.8	-11.9	15.1	-7.0	-27.4	-15.6	-19.1	-12.1	-38.4	-30.1
	10°	1	25.8	-10.7	17.1	-6.2	-27.4	-16.6	-19.1	-12.9	-38.4	-30.1
	15°	1	28.7	-9.5	19.1	-5.4	-27.4	-17.6	-19.1	-13.7	-38.4	-30.1
	20°	1	31.6	-8.3	21.1	-4.6	-27.4	-19.1	-19.1	-14.5	-38.4	-30.1
	25°	1	28.6	4.6	20.7	4.7	-12.7	-17.3	-9.2	-13.9	-23.7	-20.2
		2	—	—	—	—	-4.8	-9.4	-1.3	-6.0	—	—
	30 to 45	1	25.7	17.6	20.4	14.0	2.0	-15.6	0.7	-13.4	-9.0	-10.3
		2	25.7	17.6	20.4	14.0	9.9	-7.7	8.6	-5.5	-9.0	-10.3
130	0 to 5°	1	26.8	-13.9	17.8	-8.2	-32.2	-18.3	-22.4	-14.2	-45.1	-35.3
	10°	1	30.2	-12.5	20.1	-7.3	-32.2	-19.7	-22.4	-15.1	-45.1	-35.3
	15°	1	33.7	-11.2	22.4	-6.4	-32.2	-21.0	-22.4	-16.1	-45.1	-35.3
	20°	1	37.1	-9.8	24.7	-5.4	-32.2	-22.4	-22.4	-17.0	-45.1	-35.3
	25°	1	33.6	5.4	24.3	5.5	-14.9	-20.4	-10.8	-16.4	-27.8	-23.7
		2	—	—	—	—	-5.7	-11.1	-1.5	-7.1	—	—
	30 to 45	1	30.1	20.6	24.0	16.5	2.3	-18.3	0.8	-15.7	-10.6	-12.1
		2	30.1	20.6	24.0	16.5	11.6	-9.0	10.0	-6.4	-10.6	-12.1

Figure 6.3 Design Wind Pressures for Main Wind Resisting System (With permission from ASCE)

**Simplified Design Wind Pressure ,  $p_{S30}$  (psf) (Exposure B at  $h = 30$  ft. with  $I = 1.0$ )**

Basic Wind Speed (mph)	Roof Angle (degrees)	Load Case	Zones									
			Horizontal Pressures				Vertical Pressures				Overhangs	
			A	B	C	D	E	F	G	H	EOH	GOH
140	0 to 5°	1	31.1	-16.1	20.6	-9.6	-37.3	-21.2	-26.0	-16.4	-52.3	-40.9
	10°	1	35.1	-14.5	23.3	-8.5	-37.3	-22.8	-26.0	-17.5	-52.3	-40.9
	15°	1	39.0	-12.9	26.0	-7.4	-37.3	-24.4	-26.0	-18.6	-52.3	-40.9
	20°	1	43.0	-11.4	28.7	-6.3	-37.3	-26.0	-26.0	-19.7	-52.3	-40.9
	25°	1	39.0	6.3	26.2	6.4	-17.3	-23.6	-12.5	-19.0	-32.3	-27.5
		2	—	—	—	—	-6.6	-12.8	-1.8	-8.2	—	—
150	0 to 5°	1	35.7	-16.5	23.7	-11.0	-42.9	-24.4	-29.8	-18.9	-60.0	-47.0
	10°	1	40.2	-16.7	26.8	-9.7	-42.9	-26.2	-29.8	-20.1	-60.0	-47.0
	15°	1	44.8	-14.9	29.8	-8.5	-42.9	-28.0	-29.8	-21.4	-60.0	-47.0
	20°	1	49.4	-13.0	32.9	-7.2	-42.9	-29.8	-29.8	-22.6	-60.0	-47.0
	25°	1	44.8	7.2	32.4	7.4	-19.9	-27.1	-14.4	-21.8	-37.0	-31.6
		2	—	—	—	—	-7.5	-14.7	-2.1	-9.4	—	—
170	0 to 5°	1	45.8	-23.8	30.4	-14.1	-55.1	-31.3	-38.3	-24.2	-77.1	-60.4
	10°	1	51.7	-21.4	34.4	-12.5	-55.1	-33.8	-38.3	-25.8	-77.1	-60.4
	15°	1	57.6	-19.1	38.3	-10.9	-55.1	-36.0	-38.3	-27.5	-77.1	-60.4
	20°	1	63.4	-16.7	42.3	-9.3	-55.1	-38.3	-38.3	-29.1	-77.1	-60.4
	25°	1	57.5	9.3	41.6	9.5	-25.6	-34.8	-18.5	-28.0	-47.6	-40.5
		2	—	—	—	—	-9.7	-18.9	-2.6	-12.1	—	—
30 to 45	1	40.1	27.4	31.9	22.0	3.1	-24.4	1.0	-20.9	-14.1	-16.1	
	2	40.1	27.4	31.9	22.0	15.4	-12.0	13.4	-8.6	-14.1	-16.1	

Figure 6.4 Design Wind Pressures for Main Wind Force-Resisting System (With permission from ASCE)

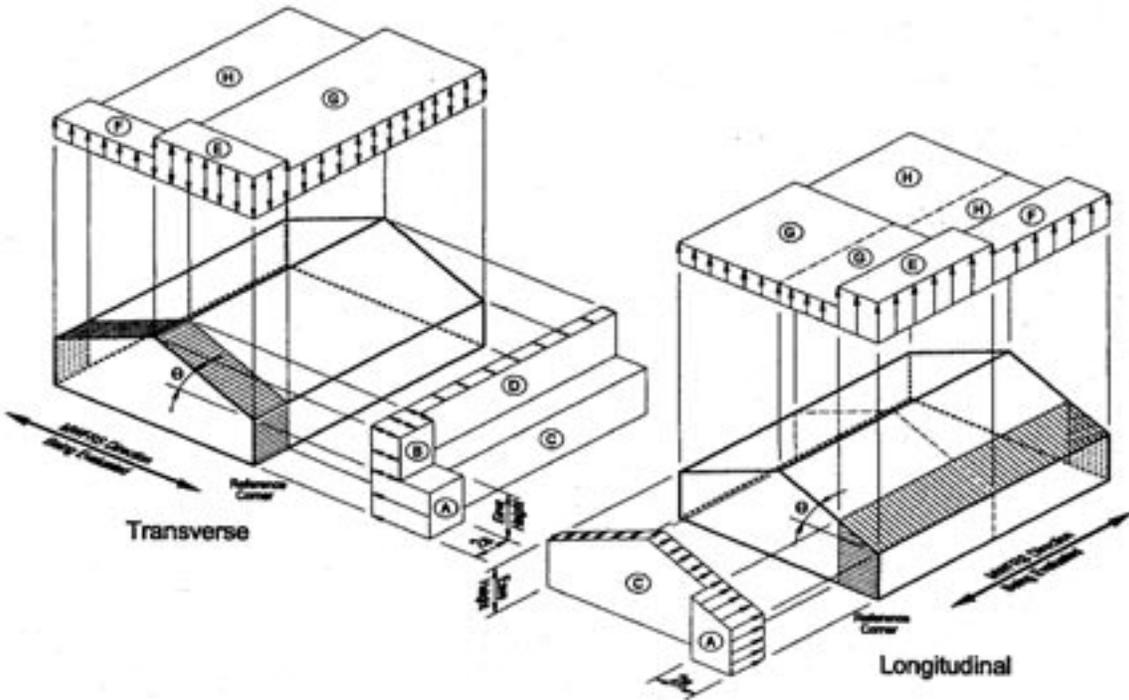

Figure 6.5 Wind Pressure Zones, Main Wind Force-Resisting System (With permission from ASCE)

Mean roof height (ft)	Exposure		
	B	C	D
15	1.00	1.21	1.47
20	1.00	1.29	1.55
25	1.00	1.35	1.61
30	1.00	1.40	1.66
35	1.05	1.45	1.70
40	1.09	1.49	1.74
45	1.12	1.53	1.78
50	1.16	1.56	1.81
55	1.19	1.59	1.84
60	1.22	1.62	1.87

Figure 6.6 Height Adjustment Factor (With permission from ASCE)

Net Design Wind Pressure,  $P_{net130}$  (psf) (Exposure B at  $h = 30$  ft. with  $I = 1.0$ )

Zone	Elev. wind line (ft)	Basic Wind Speed V (mph)																		
		85	90	100	110	120	130	140	150	170										
Roof 0 to 7 degrees	1	10	5.3	-13.0	5.9	-14.6	7.3	-18.0	8.9	-21.8	10.5	-25.9	12.4	-30.4	14.3	-35.3	16.5	-40.5	21.1	-52.0
	1	20	5.0	-12.7	5.6	-14.2	6.9	-17.5	8.3	-21.2	9.9	-25.2	11.6	-29.6	13.4	-34.4	15.4	-39.4	19.8	-50.7
	1	50	4.5	-12.2	5.1	-13.7	6.3	-16.9	7.6	-20.5	9.0	-24.4	10.6	-28.6	12.3	-33.2	14.1	-38.1	18.1	-48.9
	1	100	4.2	-11.9	4.7	-13.3	5.8	-16.5	7.0	-19.9	8.3	-23.7	9.8	-27.8	11.4	-32.3	13.0	-37.0	16.7	-47.6
	2	10	5.3	-21.8	5.9	-24.4	7.3	-30.2	8.9	-36.5	10.5	-43.5	12.4	-51.0	14.3	-59.2	16.5	-67.9	21.1	-87.2
	2	20	5.0	-19.5	5.6	-21.8	6.9	-27.0	8.3	-32.6	9.9	-38.8	11.6	-45.6	13.4	-52.9	15.4	-60.7	19.8	-78.0
	2	50	4.5	-16.4	5.1	-18.4	6.3	-22.7	7.6	-27.5	9.0	-32.7	10.6	-38.4	12.3	-44.5	14.1	-51.1	18.1	-65.7
	2	100	4.2	-14.1	4.7	-15.8	5.8	-19.5	7.0	-23.6	8.3	-28.1	9.8	-33.0	11.4	-38.2	13.0	-43.9	16.7	-56.4
	3	10	5.3	-32.8	5.9	-36.8	7.3	-45.4	8.9	-55.0	10.5	-65.4	12.4	-76.8	14.3	-89.0	16.5	-102.2	21.1	-131.3
	3	20	5.0	-27.2	5.6	-30.5	6.9	-37.6	8.3	-45.5	9.9	-54.2	11.6	-63.6	13.4	-73.8	15.4	-84.7	19.8	-108.7
	3	50	4.5	-19.7	5.1	-22.1	6.3	-27.3	7.6	-33.1	9.0	-39.3	10.6	-46.2	12.3	-53.5	14.1	-61.5	18.1	-78.9
	3	100	4.2	-14.1	4.7	-15.8	5.8	-19.5	7.0	-23.6	8.3	-28.1	9.8	-33.0	11.4	-38.2	13.0	-43.9	16.7	-56.4
Roof > 7 to 27 degrees	1	10	7.5	-11.9	8.4	-13.3	10.4	-16.5	12.5	-19.9	14.9	-23.7	17.5	-27.8	20.3	-32.3	23.3	-37.0	30.0	-47.6
	1	20	6.8	-11.6	7.7	-13.0	9.4	-16.0	11.4	-19.4	13.6	-23.0	16.0	-27.0	18.5	-31.4	21.3	-36.0	27.3	-46.3
	1	50	6.0	-11.1	6.7	-12.5	8.2	-15.4	10.0	-18.6	11.9	-22.2	13.9	-26.0	16.1	-30.2	18.5	-34.6	23.8	-44.5
	1	100	5.3	-10.8	5.9	-12.1	7.3	-14.9	8.9	-18.1	10.5	-21.5	12.4	-25.2	14.3	-29.3	16.5	-33.6	21.1	-43.2
	2	10	7.5	-20.7	8.4	-23.2	10.4	-28.7	12.5	-34.7	14.9	-41.3	17.5	-48.4	20.3	-56.2	23.3	-64.5	30.0	-82.8
	2	20	6.8	-19.0	7.7	-21.4	9.4	-26.4	11.4	-31.9	13.6	-38.0	16.0	-44.6	18.5	-51.7	21.3	-59.3	27.3	-76.2
	2	50	6.0	-16.9	6.7	-18.9	8.2	-23.3	10.0	-28.2	11.9	-33.6	13.9	-39.4	16.1	-45.7	18.5	-52.5	23.8	-67.4
	2	100	5.3	-15.2	5.9	-17.0	7.3	-21.0	8.9	-25.5	10.5	-30.3	12.4	-35.5	14.3	-41.2	16.5	-47.3	21.1	-60.8
	3	10	7.5	-30.6	8.4	-34.3	10.4	-42.4	12.5	-51.3	14.9	-61.0	17.5	-71.6	20.3	-83.1	23.3	-95.4	30.0	-122.5
	3	20	6.8	-28.6	7.7	-32.1	9.4	-39.6	11.4	-47.9	13.6	-57.1	16.0	-67.0	18.5	-77.7	21.3	-89.2	27.3	-114.5
	3	50	6.0	-26.0	6.7	-29.1	8.2	-36.0	10.0	-43.5	11.9	-51.8	13.9	-60.8	16.1	-70.5	18.5	-81.0	23.8	-104.0
	3	100	5.3	-24.0	5.9	-26.9	7.3	-33.2	8.9	-40.2	10.5	-47.9	12.4	-56.2	14.3	-65.1	16.5	-74.8	21.1	-96.0
Roof > 27 to 45 degrees	1	10	11.9	-13.0	13.3	-14.6	16.5	-18.0	19.9	-21.8	23.7	-25.9	27.8	-30.4	32.3	-35.3	37.0	-40.5	47.6	-52.0
	1	20	11.6	-12.3	13.0	-13.6	16.0	-17.1	19.4	-20.7	23.0	-24.6	27.0	-28.9	31.4	-33.5	36.0	-38.4	46.3	-49.3
	1	50	11.1	-11.5	12.5	-12.8	15.4	-15.9	18.6	-19.2	22.2	-22.8	26.0	-26.8	30.2	-31.1	34.6	-35.7	44.5	-45.8
	1	100	10.8	-10.8	12.1	-12.1	14.9	-14.9	18.1	-18.1	21.5	-21.5	25.2	-25.2	29.3	-29.3	33.6	-33.6	43.2	-43.2
	2	10	11.9	-15.2	13.3	-17.0	16.5	-21.0	19.9	-25.5	23.7	-30.3	27.8	-35.6	32.3	-41.2	37.0	-47.3	47.6	-60.8
	2	20	11.6	-14.5	13.0	-16.3	16.0	-20.1	19.4	-24.3	23.0	-29.0	27.0	-34.0	31.4	-39.4	36.0	-45.3	46.3	-58.1
	2	50	11.1	-13.7	12.5	-15.3	15.4	-18.9	18.6	-22.9	22.2	-27.2	26.0	-32.0	30.2	-37.1	34.6	-42.5	44.5	-54.6
	2	100	10.8	-13.0	12.1	-14.6	14.9	-18.0	18.1	-21.8	21.5	-25.9	25.2	-30.4	29.3	-35.3	33.6	-40.5	43.2	-52.0
	3	10	11.9	-15.2	13.3	-17.0	16.5	-21.0	19.9	-25.5	23.7	-30.3	27.8	-35.6	32.3	-41.2	37.0	-47.3	47.6	-60.8
	3	20	11.6	-14.5	13.0	-16.3	16.0	-20.1	19.4	-24.3	23.0	-29.0	27.0	-34.0	31.4	-39.4	36.0	-45.3	46.3	-58.1
	3	50	11.1	-13.7	12.5	-15.3	15.4	-18.9	18.6	-22.9	22.2	-27.2	26.0	-32.0	30.2	-37.1	34.6	-42.5	44.5	-54.6
	3	100	10.8	-13.0	12.1	-14.6	14.9	-18.0	18.1	-21.8	21.5	-25.9	25.2	-30.4	29.3	-35.3	33.6	-40.5	43.2	-52.0
Wall	4	10	13.0	-14.1	14.6	-15.8	18.0	-19.5	21.8	-23.6	25.9	-28.1	30.4	-33.0	35.3	-38.2	40.5	-43.9	52.0	-56.4
	4	20	12.4	-13.5	13.9	-15.1	17.2	-18.7	20.8	-22.6	24.7	-26.9	29.0	-31.6	33.7	-36.7	38.7	-42.1	49.6	-54.1
	4	50	11.6	-12.7	13.0	-14.3	16.1	-17.6	19.5	-21.3	23.2	-25.4	27.2	-29.8	31.6	-34.6	36.2	-39.7	46.6	-51.0
	4	100	11.1	-12.2	12.4	-13.6	15.3	-16.8	18.5	-20.4	22.0	-24.2	25.9	-28.4	30.0	-33.0	34.4	-37.8	44.2	-48.6
	4	500	9.7	-10.8	10.9	-12.1	13.4	-14.9	16.2	-18.1	19.3	-21.5	22.7	-25.2	26.3	-29.3	30.2	-33.6	38.8	-43.2
	5	10	13.0	-17.4	14.6	-19.5	18.0	-24.1	21.8	-29.1	25.9	-34.7	30.4	-40.7	35.3	-47.2	40.5	-54.2	52.0	-69.6
	5	20	12.4	-16.2	13.9	-18.2	17.2	-22.5	20.8	-27.2	24.7	-32.4	29.0	-38.0	33.7	-44.0	38.7	-50.5	49.6	-64.9
	5	50	11.6	-14.7	13.0	-16.5	16.1	-20.3	19.5	-24.6	23.2	-29.3	27.2	-34.3	31.6	-39.8	36.2	-45.7	46.6	-58.7
	5	100	11.1	-13.5	12.4	-15.1	15.3	-18.7	18.5	-22.6	22.0	-26.9	25.9	-31.6	30.0	-36.7	34.4	-42.1	44.2	-54.1
	5	500	9.7	-10.8	10.9	-12.1	13.4	-14.9	16.2	-18.1	19.3	-21.5	22.7	-25.2	26.3	-29.3	30.2	-33.6	38.8	-43.2

Figure 6.7 Net Pressure for Components and Cladding Design (With permission from ASCE)

**Roof Overhang Net Design Wind Pressure ,  $p_{net30}$  (psf)**

(Exposure B at  $h = 30$  ft. with  $I = 1.0$ )

	Zone	Effective Wind Area (sf)	Basic Wind Speed V (mph)							
			90	100	110	120	130	140	150	170
Roof 0 to 7 degrees	2	10	-21.0	-25.9	-31.4	-37.3	-43.8	-50.8	-58.3	-74.9
	2	20	-20.8	-25.5	-30.8	-36.7	-43.0	-49.9	-57.3	-73.6
	2	50	-20.1	-24.9	-30.1	-35.8	-42.0	-48.7	-55.9	-71.8
	2	100	-19.8	-24.4	-29.5	-35.1	-41.2	-47.8	-54.9	-70.5
	3	10	-34.6	-42.7	-51.6	-61.5	-72.1	-83.7	-96.0	-123.4
	3	20	-27.1	-33.5	-40.5	-48.3	-56.6	-65.7	-75.4	-96.8
	3	50	-17.3	-21.4	-25.9	-30.8	-36.1	-41.9	-48.1	-61.8
	3	100	-10.0	-12.2	-14.8	-17.6	-20.6	-23.9	-27.4	-35.2
Roof > 7 to 27 degrees	2	10	-27.2	-33.5	-40.6	-48.3	-56.7	-65.7	-75.5	-96.9
	2	20	-27.2	-33.5	-40.6	-48.3	-56.7	-65.7	-75.5	-96.9
	2	50	-27.2	-33.5	-40.6	-48.3	-56.7	-65.7	-75.5	-96.9
	2	100	-27.2	-33.5	-40.6	-48.3	-56.7	-65.7	-75.5	-96.9
	3	10	-45.7	-56.4	-68.3	-81.2	-95.3	-110.6	-128.9	-163.0
	3	20	-41.2	-50.9	-61.6	-73.3	-86.0	-99.8	-114.5	-147.1
	3	50	-35.3	-43.6	-52.8	-62.8	-73.7	-85.5	-98.1	-126.1
	3	100	-30.9	-38.1	-46.1	-54.9	-64.4	-74.7	-85.8	-110.1
Roof > 27 to 45 degrees	2	10	-24.7	-30.5	-36.9	-43.9	-51.5	-59.8	-68.6	-88.1
	2	20	-24.0	-29.6	-35.8	-42.6	-50.0	-58.0	-66.5	-85.5
	2	50	-23.0	-28.4	-34.3	-40.8	-47.9	-55.6	-63.8	-82.0
	2	100	-22.2	-27.4	-33.2	-39.5	-46.4	-53.8	-61.7	-79.3
	3	10	-24.7	-30.5	-36.9	-43.9	-51.5	-59.8	-68.6	-88.1
	3	20	-24.0	-29.6	-35.8	-42.6	-50.0	-58.0	-66.5	-85.5
	3	50	-23.0	-28.4	-34.3	-40.8	-47.9	-55.6	-63.8	-82.0
	3	100	-22.2	-27.4	-33.2	-39.5	-46.4	-53.8	-61.7	-79.3

Figure 6.8 Net Pressure for Components and Cladding Design (With permission from ASCE)

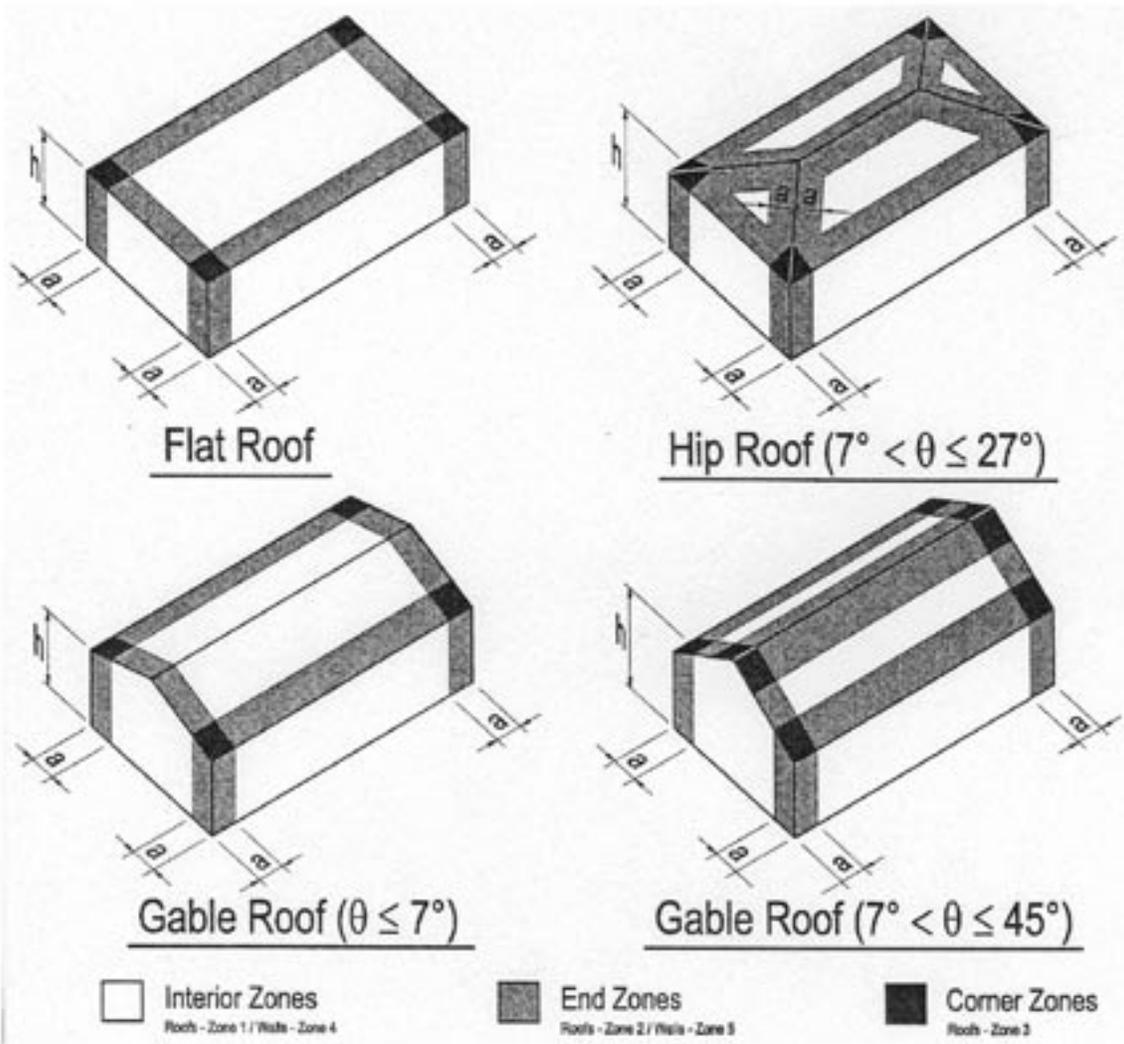

Figure 6.9 Wind Load Areas for Components and Cladding Design (With permission from ASCE)

Flood Loads

Hydrostatic and flood loads are addressed in Section 5.0 of ASCE 7.

For below-grade structures, Section 5.1 provides a lateral soil pressure as a function of soil type. In the event of flooding, the full hydrostatic load in addition to the soil pressure (minus buoyancy) is to be included. For slabs and below-grade floors, uplift force is calculated based on the full hydrostatic pressure applied on the entire slab surface. Expansive soil forces are to be accounted for as well.

Section 5.3 specifies flood loads. In general, buildings are to be designed to resist flotation, collapse, and permanent lateral displacement. Erosion and scour effects also

## FINAL REVIEW

need to be considered.

Walls designed to break away during flooding must be designed to carry a maximum of: 1) the design wind load; 2) seismic loads; or 3) 10 PSF of lateral pressure. Generally, break-away walls are to resist no more than 20 PSF of lateral pressure. Two design exceptions are listed.

ASCE 7 makes note of hydrostatic loads, hydrodynamic loads, and wave loads. Additional procedures are given to determine design breaking wave loads on columns and walls.

For hydrostatic loads, structures are to be designed to withstand hydrostatic pressure caused by the depth of water equal to the *design flood elevation* + 1 foot (see the section describing ASCE 24 in this report).

For hydrodynamic loads, little guidance is provided, other than the loads are to be determined by “a detailed analysis utilizing basic concepts of fluid mechanics.” An exception is provided when water velocities do not exceed 10 feet per second. In this case, an equivalent static load can be used which is given by increasing the design flood elevation by the result of the following equation:

$$d_h = \frac{aV^2}{2g} \quad (6.27)$$

Where:

V = average velocity of water, feet per second

g = acceleration due to gravity (32.2 feet per second)

a = coefficient of drag or shape factor (not taken less than 1.25)

For wave loads, effects can be determined using either a simplified method detailed below, by a “more advanced” numerical procedure, or by experimental modeling. Wave loads need to be considered for structures within V-Zones and A-Zones (see the section describing ASCE 24 in this report). V-Zone waves are to be taken as a minimum of 3 feet high and less than 3 feet high in areas landward of the V-Zone.

Breaking wave heights  $H_b$  for V and A Zones are taken as a linear function of local stillwater depth,  $d_s$ , and are calculated with:

$$H_b = 0.78d_s \quad (6.28)$$

In lieu of more advanced procedures, local stillwater depth can be calculated with:

$$d_s = 0.65(\text{BFE} - G) \quad (6.29)$$

Where BFE is the Base Flood Elevation (see the section describing ASCE 24 in this

**FINAL REVIEW**

report) and  $G$  is the ground elevation in feet.

An equivalent static horizontal force,  $F_D$ , from breaking waves is applied to pilings and columns and is assumed to act at the stillwater elevation and is given by:

$$F_D = 0.5 \gamma_w C_D H_b^2 \tag{6.30}$$

Where:

$\gamma_w$  = unit weight of water (62.4 PCF for fresh water and 64.0 PCF for salt water)  
 $C_D$  = coefficient of drag for breaking waves, taken as 1.75 for round columns and 2.25 for square

columns

$D$  = pile or column diameter (feet) for circular columns, or 1.4 times the width of the column for

square sections

For walls subjected to breaking waves, maximum water pressure  $P_{max}$  is calculated as:

$$P_{max} = C_p \gamma_w d_s + 1.2 \gamma_w d_s \tag{6.31}$$

The breaking wave force  $F_t$  per unit length of the wall at the stillwater elevation is given as:

$$F_t = 1.1 C_p \gamma_w d_s^2 + 2.4 \gamma_w d_s^2 \tag{6.32}$$

In these equations,  $C_p$  is a dynamic pressure coefficient that varies from 1.6 to 3.5, and is given as a function of building occupancy (i.e. importance) type.

These simple procedures assume that the wall is dry on the opposite side; if standing water surrounds the wall, a specified adjustment to the equations is necessary. Simple adjustments are also given for non-vertical walls and waves striking a wall at an oblique angle.

**2005 ASCE 24**

ASCE 24 provides guidelines for flood-resistant design. Specifically, the standard is written for buildings located in Flood Hazard Areas. Separate sections apply to different flood situations, such as new construction in Flood Hazard Areas, High Risk Flood Hazard Areas, and Coastal High Hazard Areas and Coastal A Zones.

Some fundamental terms relevant to the standard are as follows:

A Zone: An area within the Special Flood Hazard Area not subject to high velocity wave action.

Coastal A Zone: Areas not designated by FEMA but where wave forces and potential erosion should be considered. These zones lie landward of FEMA V Zones and landward of an open coastal shoreline where V Zones have not been mapped. For a Coastal A Zone to be present, two conditions must be satisfied: 1) a Stillwater depth of 2' or greater,

## FINAL REVIEW

and 2) breaking wave heights equal to 1.5' or greater.

Coastal V-Zone (Coastal High-Hazard Area): This is within a Special Flood Hazard Area subjected to high-velocity wave action. It usually extends from off-shore to the inland limit of a primary frontal dune along an open coast.

Design Flood Elevation (DFE): Higher of the Base Flood Elevation (BFE) shown on FEMA FIRMs or determined by the local community. Note that elevating a building to the DFE will provide no safety factor for flooding. This can be achieved by adding additional height (freeboard) to the structure.

Flood Hazard Boundary Map (FHBM): Flood risk map prepared by FEMA which identifies flood hazard areas having a 1% or greater chance to flood in any year.

Flood Insurance Rate Map (FIRM): Community map on which FEMA has designated the special hazard areas and the risk premium zones.

ASCE 24 requires that the elevation of structures be set at the Design Flood Elevation (DFE) or higher, based on an importance factor.

Although load combinations are referred to in ASCE 7, no specific flood loads are specified in ASCE 24. Rather, the standard states buildings are to be designed to resist all flood-related loads and conditions, including: hydrostatic loads, hydrodynamic loads, wave action, debris impact, rapid rise and rapid drawdown of floodwaters, prolonged inundation, alluvial fan flooding, wave-induced and flood-related erosion and scour, and sediment deposition, among others. The Commentary (section C1.6.1) also avoids specifying loads, but notes that “some flood-related loads... may exceed those typical [such as wind] loads by a factor of 10 to 100, or more.” How the structural engineer is to obtain these design loads is not clear.

Brief guidelines describe the use of fill material, slab-on grade construction, footing design, pile foundations, openings in the structure, shear walls, and materials. However, these guidelines in general reference other standards and provide minimal specific design requirements.

### **Comparison of Code-Specified and Observed Loads**

#### Wind Gusts

Figure 6.10 shows superimposed ASCE 7 design wind speed gusts to wind gusts estimated for Hurricane Katrina. The actual wind loads were estimated by numerical simulation from the National Oceanic and Atmospheric Association (NOAA) Atlantic Oceanography and Meteorology Lab Hwinds models as well as in situ data collection. NOAA reports that the model values were lower than official wind station records.

The design winds were exceeded over a relatively narrow swath of land in the southeastern portion of the state. The maximum difference between the estimated actual

wind speed and the design wind speed is approximately 30 MPH. The peak difference occurred just south of the 110 MPH wind design speed contour, where the estimated peak 140 MPH wind gust contour appears. Data from other sources (Table 3.6) generally revealed lower extreme values than the NOAA estimate, as shown in Table 6.4. With the exception of Slidell and Waveland, the estimates are in reasonable agreement.

Table 6.4. Estimated and Measured Wind Gusts

Location	Estimated Gusts, Table 3.6	Estimated Gust, NOAA
Slidell, LA	105 (MPH)	135 (MPH)
Waveland, MS	122-130	145
Biloxi, MS	110-115	100
Ocean Springs, MS	105	100
Pascagoula, MS	100	95

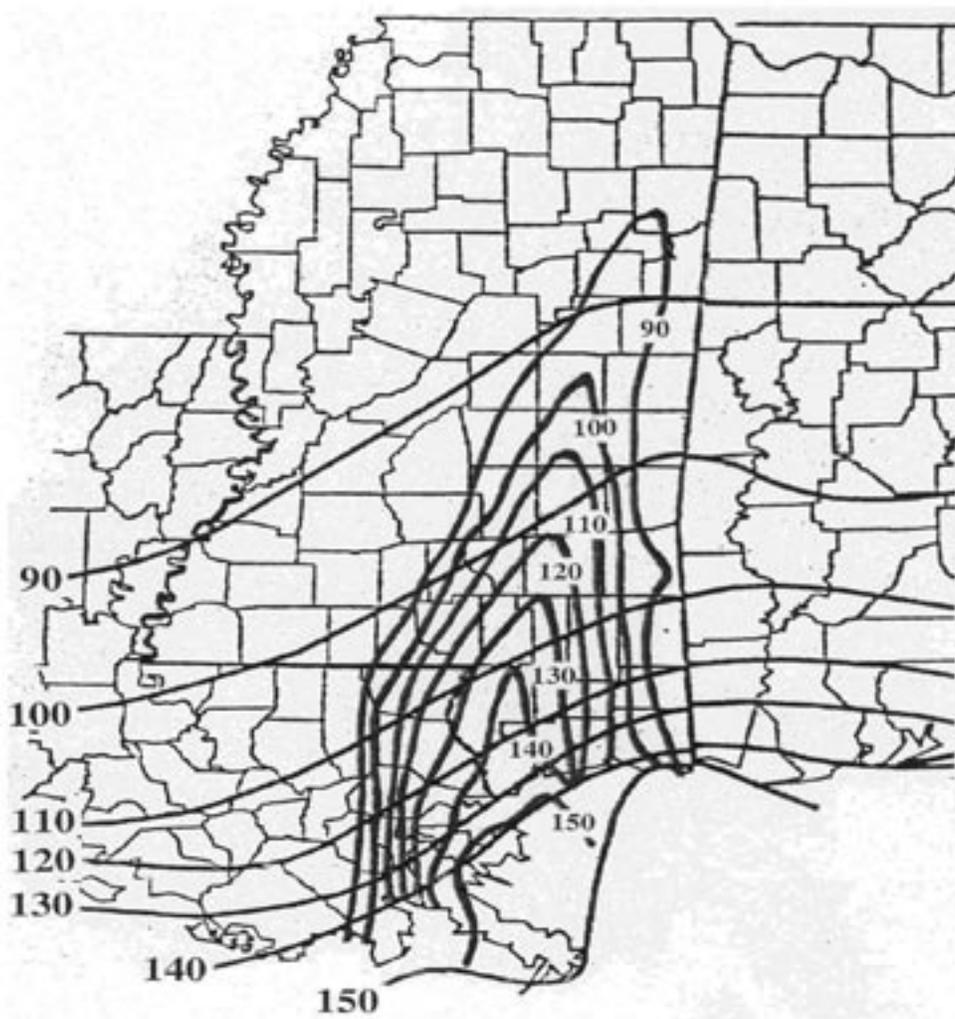

Figure 6.10 Code (horizontal contours) and Simulated (vertical contours) Wind Gusts (MPH)

## FINAL REVIEW

### Storm Surge

Table 6.5 compares FEMA Design Flood Elevations (DFE) to observed and simulated high-water levels for several communities along the Gulf Coast. In each case considered, the DFE was exceeded. Referring to Figure 3.17, coastal high water elevations along the Mississippi Gulf Coast from Waveland to Gulfport varied in the range of approximately 25-30', and from Gulfport to Pascagoula from about 15-20'. In contrast, FEMA DFEs along the coast from Waveland to Gulfport vary from 11-19', while from Gulfport to Pascagoula vary from 9-19'.

Table 6.5. Comparison of Design Flood Elevations and Katrina High Water Levels

Location	FEMA DFE	Observed Katrina Water Level, Table 3.8	Simulated Katrina Water Level, Figure 3.17
Pass Christian	13-18 (FT)	25 (FT)	25-30 (FT)
Bay St. Louis	13-17	27	25-30
Gulfport	13	22	25-30
Pascagoula	10-13	12, 15, 17	15-20

**CHAPTER 7**

**CONCLUSIONS AND RECOMMENDATIONS**

Christopher D. Eamon, PhD, PE,  
Assistant Professor of Civil Engineering,

William H. McAnally, PhD, P.E. F.ASCE  
Associate Professor

and

Thomas D. White, PhD, P.E.  
Professor and Head  
Construction and Material Industries Chair  
Department of Civil Engineering  
Bagley College of Engineering  
Mississippi State University

**Conclusions**

A combination of shallow offshore bathymetry and low onshore topography dictate the Mississippi Gulf coast is highly susceptible to future hurricane damage from both winds and storm surge. The current Saffir-Simpson scale for hurricanes originating in the Atlantic Ocean was not effective in identifying storm surge magnitude experienced along the Mississippi and Louisiana Gulf Coast from Hurricane Katrina.

Historically and practically, towns along the Mississippi Gulf Coast were built at sites offering access to the Gulf and at the same time be least subject to storm surge damage. The analogy is the area of New Orleans suffering least damage from Hurricane Katrina is the (old) French Quarter and other historical areas of the city. In modern times the Mississippi Gulf Coast has experienced significant economic development. This development is driven by a growing casino and tourist industry, retirement developments, shipbuilding, government installations, port operations and general commercial development attracted by an increased population. Demand for commercial and residential development extended into areas with high risk of storm surge and flooding.

Proposed building codes will increase design wind loads. However, an area of the coast and inland was subjected to winds 30mph higher than those being proposed. More significantly, existing land use policy did not anticipate storm surge magnitude experienced by a significant portion of the Mississippi Gulf Coast and as a result, the most severe damage was caused by storm surge. A study of the building codes being proposed and the documents referenced for flood (storm surge) loads (ASCE 7) do not provide clear guidance on storm surge loading likely from a major hurricane.

## FINAL REVIEW

Along the Gulf Coast, structures and infrastructure performance primarily depended on whether they were subjected to significant storm surge. From a materials perspective; reinforced concrete, structural steel sections, structural timber sections and stay-in-place formed reinforced concrete performed from fair to well when subjected to both storm surge and wind loading

Engineer designed structures of reinforced concrete, structural steel, and timber performed well during the storm surge. This suggests existing design criteria and construction practices for these types of structures either included storm surge loading or include adequate capacity for this additional mode of loading. This issue has a degree of uncertainty.

There were a number of instances prestressed concrete structures exposed to storm surge loading did not perform well. In some of these cases member capacity appeared adequate but members were placed on supports and were expected to stay in place by gravity. When impacted by storm surge loads they were displaced from the supports and fell. In other cases connections were inadequate or faulty.

Most light-frame wood structures subjected to storm surge were destroyed and it appears failure initiated at fasteners. However, it is not known whether strengthened connections alone would decrease damage because the overall structural capacity of such structures when lateral storm surge load is considered is much less than that of typical engineered structures that survived.

Building facades of all types subject to storm surge performed poorly. Even facades of engineered structures when subject to storm surge failed. In most instances the first floor of such structures were stripped of the façade and interior furnishings and partitions.

US Highway 90 bridges spanning the Biloxi Back Bay and Bay St. Louis and several Casino parking garages with large horizontal surfaces were subject to transient uplift and side forces imposed by storm surge. In simply supported structures as these, the transients were of sufficient duration and magnitude to displace the simply supported components from the supporting structures resulting in structural failure.

### **Recommendations**

While in the Gulf of Mexico, Hurricane Katrina strengthened to a Category 4 Hurricane before decreasing to Category 3 prior to landfall on the Mississippi and Louisiana coasts. This decrease to Category 3 was reported along with wind speeds and storm surge in the Saffir-Simpson hurricane classification scale. There was a noticeable sense of relief with the decrease in winds to Category 3. What seemed to be lost was concern that an extremely high storm surge could still occur as footnoted on the full Saffir-Simpson scale (Chapter 3.) As a result, a modification to the scale is recommended to clearly communicate to the public and responders potential storm surge magnitudes. The format of the MSU Saffir-Simpson scale (Table 7.1) is:

Table 7.1 MSU Saffir-Simpson Scale for Atlantic Hurricanes.

Category	Maximum sustained winds	Storm Surge (approximate)		
	mph	feet		
		a	b	c
1 (Minimal)	74-95		4-5	
2 (Moderate)	96-110		6-8	
3 (Extensive)	111-130		9-12	
4 (Extreme)	131-155		13-18	
5 (Catastrophic)	> 155		> 18	

The above is an abbreviated table to highlight addition of the three levels of storm surge, a, b and c. Current work is underway to add definition to the storm surge levels.

One way of reducing storm surge damage is to adopt land use policies restricting certain types of development. Structures in these areas should functionally account for potential storm surge which may mean the first one to two stories are expected to be inundated. Structurally, buildings should be designed for both storm surge and wind.

Projected winds along the coast from Hurricane Katrina exceeded wind map contours in ASCE 7. Consequently, the adequacy of design wind speed contours along the coast should be reconsidered. Also, Mississippi is subjected to high winds from thunderstorms and tornados yearly. Statewide building code adoption and implementation with engineering certification and inspection may greatly mitigate such wind and storm damage.

Current concepts in structural analysis consider probability of occurrence of design loads. Probability is expressed on the basis of rate of return and expected loads from that rate of return.

a. Load rate of return. A “100-year” flood (i.e. 1% chance of a flood of a magnitude per year) is the most typical rate of return used for flood design. A determination must be made whether this rate of return is adequate for hurricane storm surge potential. Longer or shorter rates of return may apply. In effect a longer rate of return means a more severe storm surge could occur. As such, a higher rate of return leads to higher design storm surge and a more conservative (higher) design load.

b. Expected loads. Currently, design loads are determined which utilize flood levels for a given rate of return and simplified procedures in ASCE 7. This process needs to be critically reviewed. First, appropriate storm surge levels need to be determined for the Gulf Coast. However, even with an expected storm surge

## FINAL REVIEW

level, ASCE 7 provides minimal guidance on obtaining hydrodynamic loads. A standardized procedure should be developed for calculating water loads.

Ideally, all locations within the U.S., including the State of Mississippi, should be held to a consistent set of design standards. If correctly formatted, the procedure would produce different design loads from one geographic location to another because of variations in risk. However, this format would produce a consistent level of safety or a consistent failure probability and arbitrary under or over-design is minimized.

For those structures that collapsed, it would be useful to determine, if possible, what standards they were designed to. Clearly, the capacity of the failed structures was inadequate to carry the imposed loads. An investigation to determine the desired and current design strength is recommended. Particular attention should be paid to connection and fastener strengths.

Structures such as parking garages and bridges subject storm surge and wind loadings should be analyzed for combined loadings of wind and water that includes buoyancy, hydrostatic and hydrodynamic water forces. In particular, support systems should incorporate motion limiting mechanisms to prevent collapse such as with earthquake loadings.

As noted above, wood frame construction along the Gulf Coast was damaged severely by the storm surge and severely to moderately by wind. Even inland, wood frame elements were damaged. The appropriate "Rate of Return" and associated storm loadings described above can be utilized to determine appropriateness of existing as well as proposed building codes.

Building facades were particularly vulnerable to storm surge loadings. Facades subjected to storm surge can either be designed to be sacrificial, with the understanding that the contents of associated floors are sacrificial as well, or designed to resist storm surge. Of course in the latter case, care must be taken to insure that the supporting structural system has the required resistance to carry these additional loads.

In all cases, above conclusions and recommendations are based on storm surge and wind loadings experienced with Hurricane Katrina.

## FINAL REVIEW

### References

*AASHTO Standard Specifications for Highway Bridges*, 17<sup>th</sup> Ed. American Association of State and Transportation Officials. Washington, DC, 2002.

*AASHTO LRFD Bridge Design Specifications*. American Association of State and Transportation Officials. Washington, DC, 2004.

*ACI 318-05 Building Code and Commentary*. American Concrete Institute. Farmington Hills, MI, 2005.

*ACI 530 Building Code Requirements for Masonry Structures*. American Concrete Institute. Farmington Hills, MI, 2005.

*ASCE Standard 24-05: Flood Resistant Design and Construction*. American Society of Civil Engineers. Reston, VA, 2002.

*ASCE Standard 7-02: Minimum Design Loads for Buildings and Other Structures*. American Society of Civil Engineers. Reston, VA, 2002.

Cardone V.J., C.V. Greenwood, and J.A. Greenwood, 1992. Unified program for the specification of hurricane boundary layer winds over surfaces of specified roughness. Contract Rep. CERC-92-1, U.S. Army COE, 85 pp.

Carr, L. E., and R. L. Elsberry, 1997. "Models of tropical cyclone wind distribution and beta-effect propagation for application to tropical cyclone track forecasting." *Monthly Weather Review*, Vol. 125, 3190-3209.

Holland, G. J., 1980. "An analytical model of the wind and pressure profiles in hurricanes." *Monthly Weather Review*, Vol. 106, 1212-1218.

HRC, 2006, Post-Tropical Cyclone Report for Hurricane Katrina, National Oceanic and Atmospheric Administration, Hurricane Research Center, [http://www.srh.noaa.gov/lix/html/psh\\_katrina.htm](http://www.srh.noaa.gov/lix/html/psh_katrina.htm), accessed Jan 2006.

HRD 2006, Katrina 2005 wind analyses, National Oceanic and Atmospheric Administration, Hurricane Research Division, [http://www.aoml.noaa.gov/hrd/Storm\\_pages/katrina2005/wind.html](http://www.aoml.noaa.gov/hrd/Storm_pages/katrina2005/wind.html), accessed Jan 2006.

*International Building Code*. International Code Council. Country Club Hills, IL., 2003.

*International Residential Code*. International Code Council. Country Club Hills, IL., 2003.

Jacobsen, B., J. Suyhada, P. J. Fitzpatrick, Y. Li, and E. Valenti, 2005: The sensitivity of

## FINAL REVIEW

the hurricane storm surge to the Mississippi River Gulf Outlet. Final report, URS Corp.

Jarvinen, B.R., and M.B. Lawrence, 1985. "An evaluation of the SLOSH storm-surge model." *Bulletin of the American Meteorological Society*, Vol. 66, 1408-1411.

Jelesnianski, C. P., J. Chen, and W. A. Shaffer, 1992. *SLOSH: Sea, lake, and overland surges from hurricanes*. NOAA Tech. Report NWS 48, 71 pp.

Liu, K. S., and C. L. Chan, 1999. "Size of tropical cyclones as inferred from ERS-I and ERS-II data." *Monthly Weather Review*, Vol. 127, 2992-3001.

*LRFD Manual for Engineered Wood Construction*. American Forest and Paper Association. Washington, D.C., 2005.

Luettich, R. A., J. J. Westerink, and N. W. Scheffner, 1992. ADCIRC: An advanced three-dimensional circulation model for shelves, coasts, and estuaries, report 1: Theory and Methodology of ADCIRC-2DDI and ADCIRC-3DL. Technical Report DRP-92-6, U.S. Army Engineers.

Luettich, R. A., and J. J. Westerink, 2000. ADCIRC: A (parallel) advanced circulation model for oceanic, coastal, and estuarine waters. [Available online at <http://www.marine.unc.edu/CATS/adcirc/adcirc.html>].

*Manual of Steel Construction, Allowable Stress Design, 9<sup>th</sup> Ed.* American Institute of Steel Construction. Chicago, IL., 1989.

*Manual of Steel Construction, Load and Resistance Factor Design, 3<sup>rd</sup> Ed.* American Institute of Steel Construction. Chicago, IL., 2001.

MARIS, 2005, Mississippi Automated Resource Information System, [www.maris.state.ms.us](http://www.maris.state.ms.us), accessed December 2005.

*National Building Code*. Building Officials and Code Administrators, 1999.

*National Design Specification for Wood Construction*. American Forest and Paper Association. Washington, D.C., 2005.

Simpson, R. H., 1974. "The hurricane disaster potential scale." *Weatherwise*, Vol. 27, 169,186.

*Standard Building Code*. Southern Building Code Congress International. Country Club Hills, IL., 1999.

*Steel Construction Manual, ASD/ LRFD*. American Institute of Steel Construction. Chicago, IL., 2005.

## FINAL REVIEW

*Uniform Building Code*. International Conference of Building Officials. Whittier, CA, 1997.

Valenti, E., P. J. Fitzpatrick, and Y. Li, 2005. "Web-Based Hurricane Storm Surge and Flood Forecasting Using Optimized IFSAR Bald Earth DEMs." SBIR Phase II Final Report, WorldWinds, Inc.

Westerwink, J.J., R.A. Luettich, C.A. Blain, and N.W. Scheffner, 1992. ADCIRC: An advanced three-dimensional circulation model for shelves, coasts, and estuaries, report 2: User Manual for ADCIRC-2DDI. Technical Report DRP-92-6, U.S. Army Engineers.

Westerwink, J.J., R.A. Luettich, and J.C. Muccino, 1994. "Modeling tides in the western North Atlantic using unstructured graded grids." *Tellus*, Vol. 46A, 178-199.

**APPENDIX: PROCEEDINGS FOR DECEMBER 13, 2005 BUILDING CODE WORKSHOP HELD IN HATTIESBURG, MS**

**A 1.1 History of International Codes**

by: Stephen V. Skalko, P.E.

**Slide A1.2**

The first model building code in the United States was a building code developed by the National Bureau of Fire Underwriters which was basically an organization made up of insurance companies. The reason they put together this code was because they realized the need to come up with some way to influence uniform construction in our cities. By addressing safety issues, perhaps we can even out the risk levels across the cities and minimize risk to citizens and property. There would also be some continuity with how we build our buildings. They developed a grading system for cities to use. I'm sure you have heard of grading systems like ISO. They would use the code that they had developed in 1905 called the National Building Code and encouraged cities to adopt and use it to gauge a cities commitment to safety. This building code was used as a model code primarily for cities in the northeast part of the country. From there it began to have some influence in setting design standards that design professionals, contractors, or local agencies would follow.

**Slide A1.3**

The National Building Code went through revisions. Periodic revisions that it would go through were done by the National Board of Fire Underwriters mostly based on their experiences. Successful methods of construction were improved on and poor practices were deleted. Revisions also were driven by changes in the methods of construction and materials. If you look at older buildings and track them, we changed the way we built buildings, thus there is nothing new about changes in buildings codes today because we use different materials and different methods and newer codes reflect those changes. Revisions to the National Building Code were done by a professional staff and it was done in a closed environment. I think it's understandable because the insurance companies were primarily looking to minimize their risk of loss they wanted the largest amount of input in these documents. They carried on this process through about fourteen additions from 1905 up through 1976. One of the more interesting things that happened over that period of time was that as we moved into the early 1920's less jurisdictions across the country were using that document. This was because there were other model codes available on the market that better suited the building needs for certain regions.

**Slide A1.4**

In the early 1900s we move to regional model codes. One of the first regional model codes to get developed was by the International Conference of Building Officials (ICBO), a loosely formed group of folks on the west coast. One reason they formed in 1922 was because they found that they could get together and share their experiences in the western part of the country on what and how they build and what was working and what served the best purpose for their citizens. They also found that they needed a code that better

## FINAL REVIEW

suited their needs than what the National Building Code (NBC) could provide them on the west coast. The NBC was mostly an east coast type code. So in fact in 1927 they produced a regional code known as the Uniform Building Code (UBC) and that building code served its purpose well in a major part of the western part of the US for quite a few years.

### **Slide A1.5**

Not to be outdone, you know how we are down here in the south. We have a strong sense of our own identity as southerners and the Southern Building Code Congress formed in 1940. It really formed for pretty much the same reason that the International Conference of Building Officials (SBCCI) formed and that was because down here in the south we do things a little different than they do on the west coast and the northeast. Because of that there were a number of code officials that got together and said let us look at how we are doing things in the south. Let us see if we can find a code that best serves our needs. And in 1946 the SBCCI collectively produced the Southern Standard Building Code (SSBC) which has served as the model building code for quite a few years here in the southeast. In fact I think it was mentioned earlier that some areas are still using the Standard Building Code. It used to be Southern Standard Building Code but the SBCCI dropped the word "southern" to try to make it less regional and give it the opportunity to be used internationally.

### **Slide A1.6**

Alright so we can see we have a trend now. We got west coast folks and the southeast folks with their own model code. The northeast wasn't about to be left out so they formed an organization called Building Officials and Code Administrators (BOCA). Interestingly enough they actually formed their group before ICBO and SBCCI organized. They actually did it in the early 1900s. When they got together they formed this group for the same reasons that the west coast folks did and the southeast folks did and that was to share common ideas and experiences. Of course they finally realized that they probably needed their own code. Thus they developed the BOCA Basic Building Code and found that it served the people very well and perhaps even better than the National Building Code. Would anyone care to guess one reason why the Basic Building Code served them better than the National Building Code? Who was developing the National Building Code? Insurance. Yes, well there was nothing wrong with the insurance industry they were very important, but theirs was a much closed process. I recall they did all of their development internally. They ran the show by deciding what and where things happened. That's one of the things that came out of each of these development processes is that each of the three groups could go through and develop their own code and make it a much more open process. This process would allow more input from the building community as far as what was required and how it was required. And so from that stand point you ended up with the National Building Code and three different regional codes including Uniform Building Code, Standard Building Code, and BOCA Basic Building Code. Now I do want you to know that when the insurance industry stopped developing the National Building Code in 1976 that code just lay out there and finally BOCA approached them and said we would like to buy the rights to that code and just get it off the market. Some

## FINAL REVIEW

of their jurisdictions that belonged to their organization were still using it, but they wanted to go ahead and bring it off the market and make the Basic Building Code the predominant code in the northeast part of the country. And so they bought the rights to the National Building Code from the insurance industry and as part of that BOCA changed the name of their code from BOCA Basic Building Code to BOCA National Building Code. So in recent times if you ever see this document you will see it listed as the BOCA National Building Code.

### **Slide A1.7**

Now I have put here a map and this map shows you the regional influences we have and how we are in our country and we still to some extent see ourselves as west coast folks, southern folks, and northeast folks. And we do somewhat build differently in those areas because it's a thing that has been built in over time because of our association with the different model code groups and the influence of construction. These three groups are pretty much how it is reflected in the United States and what it has been like for the western parts since the 1920s, the southeast part since the 1940s and the northeast part since the 1950s in terms of building construction.

### **Slide A1.8**

A couple of things about each of those three codes that is important. How many here have even been to the code change cycles of the Standard Building Code? Not many. How many of you have ever been to the code change process for the International Codes? Ok just a few. Because many of you have not been to a code change process, I want you to realize when we were talking about the three previous codes they went through annual revision processes every year. They did it for a number of reasons. One reason is that all of a sudden you could have a natural disaster occur and you could have a building failure from fire, wind, or even an earthquake and we would find out that the way we are building doesn't work or it wasn't working as well as it should to serve the needs of the community. That allowed the code to grow and change to address the needs of the citizens by making some things more stringent or perhaps addressing some gaps or issues that were not as obvious, but should be incorporated into construction practices. Each of those three groups used the same valuable code change cycle where each was a very open process. It allowed the input from the design professional, the researchers, the code officials, and John Q citizen. Everyone was allowed an opinion on these changes. Of course the other thing that would happen besides the natural disasters is that we change the way we would construct with materials and the manner in which we construct those were also some things we were able to incorporate on an annual basis. Now, every one of those model codes groups developed a new additions of the code every third year. Every third year you would have for example the Standard Building Code had a 1985 edition then it had a 1988 edition then to a 1991 edition then a 1994 edition to a 1997 edition. The other two groups had very similar changes in their processes as well. Depending on what editions were out there plays some part in what the jurisdiction or the particular city or county might adopt or even a state if there was even a state adoption of a code at that time. Now, you have the insurance industry that started out what was viewed to be a single national building code. Obviously regional differences played a part in that it did

## FINAL REVIEW

not seem to quite work so we went to three different regional codes. But there was still a lot of interest in trying to find out if we could have some sort of commonality on some of the ways we do things because, there really isn't much difference between regions in what we do.

### **Slide A1.9**

The three groups, ICBO, BOCA and SBCCI, got together and formed a group called the Council of American Building Officials (CABO). Each of those three parties owned one third of that organization. This organization served a process to develop two documents so that these documents could hopefully get transposed into being used on a national basis for one and two family dwellings and for energy conservation.

### **Slide A1.10**

So if you ever hear the term the CABO one and two family dwelling code, in fact I brought my copy of the 1995 edition, that's what this book was intended to be a single document that tells how to descriptively build one and two family dwellings no matter where you are building around the US. Of course the home building industry had a keen interest in this because they wanted to see a little bit of uniformity with how codes requirements were applied across the country. So this is one of the documents and the Model Energy Code was the other one to get some uniformity in energy conservation.

### **Slide A1.11**

As things were rocking along some other things started taking place that caused there to be a shift away from regional codes. I have already mentioned that CABO was formed in 1970. The next thing that happened was each of these model code groups, BOCA, SBCCI, and ICBO have within their own realm a set of codes, a family of codes: they had a building code, a gas code, a mechanical code, a plumbing code, a zoning code, and an existing building code. This family of codes was what they could bring to the table for a city or county so when a city or county needed to look at a code to adopt they didn't have to go off searching for all different parts to bring together to build a building. In 1993 the International Conference of Building Officials had a partnership with another association on the west coast called the International Association of Plumbing and Mechanical Officials (IAPMO). They were responsible for development of plumbing and mechanical codes that got used with the Uniform Building Code and apparently they had some sort of differences. I don't know what it was and now it doesn't even matter, but the ICBO found out that they were not going to be able to have a plumbing and a mechanical code to use as apart of its family codes. Also, there were a lot of keen interests in the early 90s by the design professionals to want to see a single set of codes so folks would not have to look at a myriad of codes to do any design. So what happened is ICBO talked to the BOCA folks and talked to the SBCCI people and said you know we have already done this with the CABO one and two Family Dwelling Code and the Model Energy Code maybe we can do this with our remaining family codes and they formed the organization known as the International Code Council (ICC). That was done in 1994.

## FINAL REVIEW

### Slide A1.12

Of course, the ICC started developing plumbing and mechanical codes to be able to use as a joint single design document throughout the country. The ICC was going to serve as that organization to perhaps have a single set of plumbing and mechanical codes that could be used by BOCA, ICBO, and SBCCI. When this happened one of the other things that had to happen was the code groups had to stop publishing and developing their present set of codes. The first one to bite the bullet was ICBO. In 1997, they said they were no longer going to develop their building codes. So in 1997 the Uniform Building Code was the last published edition. The three organizations that created this International Code Council said, you know, why do we have CABO? We might as well make CABO fold right into the International Code because it already is a joint effort to do one and two family dwellings and they folded the CABO code into the International Codes. So you have a residential code, energy code, and mechanical and plumbing all folded into this family of codes. There was one more thing that had to happen. SBCCI and BOCA had to decide either to agree with this concept of single codes or not and if they do agree they have to do the same thing that ICBO did, which was to quit publishing their documents. So back in 1999 both BOCA and SBCCI quit developing the BOCA National Building Code and the Standard Building Code. So if someone is using one of those documents you will never see another change again. It is now a stagnant document that is no longer staying up with current practice. If you look at what the National Board of Fire Underwriters was doing they were always making revisions based on experience, what was happening, changing materials and how we build. The three model codes did the same thing and when they moved to a single set of codes and stopped changing their previous documents those documents became stagnant so to speak. They are not worthless documents because they clearly reflect on how we built when they were used, but they do not reflect some of the latest innovations based on experience. That experience could include earthquakes since 1999, wind events since 1999 or even major fire events since 1999.

### Slide A1.13

So the International set of codes is looking to be a single set of documents that can reflect how to build no matter where you are in the United States. It basically replaced the three regional codes we have been talking about. Now once they stopped revising the Standard Code and the BOCA Code they had to go ahead and get together and pull together all the differences to try to develop this remaining set of codes. They managed to do that from 1997 to 2000. They came together, managed to bring their differences together and produced a single set of family of codes.

### Slide A1.14

They also realized that one last step needed to happen. It made no sense to have three separate groups trying to make this one family set of codes work and so they reached contractual agreements and through legal actions by BOCA, ICBO and SBCCI sold their interest to the International Code Council and all got folded into one organization.

## FINAL REVIEW

### Slide A1.15

So we now do have a single, unified organization, the International Code Council, which is there to provide a family set of codes that are useable and available and can be adopted by jurisdictions. Those jurisdictions can go and adopt one family of codes that cover building, plumbing, mechanical, zoning and residential and have a family set of codes that reflect the latest typically in how we should be building. That is the kind of code that jurisdictions are going to adopt. We have come full cycle from the early days of the insurance industry's model code. That is what the International Codes can and should do is provide us with those single sets of documents. The International Codes go through the code change cycle the three model code groups previously did. There is one significant difference; under the old process we were producing a new supplement every year. They have decided that was a little too fast between editions so they fall into an eighteen month cycle. So every third year, which is two eighteen month cycles, a new set of codes will be published.

Slide A1.1

# **INTERNATIONAL CODES**

## **History, Changes, Adoptions**

**MISSISSIPPI  
BUILDING CODE WORKSHOP  
December 16, 2005**

Slide A1.2

## **The First Model Building Code**

- National Bureau of Fire Underwriters – formed by insurance companies
- Developed a fire grading system for municipalities
- Developed National Building Code 1905

Slide A1.3

## National Building Code

- Periodic revisions based on fire experience and losses
- Revisions based on changing methods of construction
- Revisions developed by staff of NBFU
- 14 editions issued through 1976

Slide A1.4

## Regional Building Codes

- International Conference of Building Officials – formed 1922
- Served as forum for sharing ideas and experience in construction for the western states
- 1927 produced Uniform Building Code

Slide A1.5

## Regional Building Codes

- Southern Building Code Congress – formed 1940
- Served as forum for sharing ideas and experience in construction for the southern states
- 1946 produced Southern Standard Building Code

Slide A1.6

## Regional Building Codes

- Building Officials and Code Administrators – formed early 1900s
- Served as forum for sharing ideas and experience in construction for the northeastern states
- 1950 produced BOCA Basic Building Code
- Bought rights to NBC - 1982

Slide A1.7

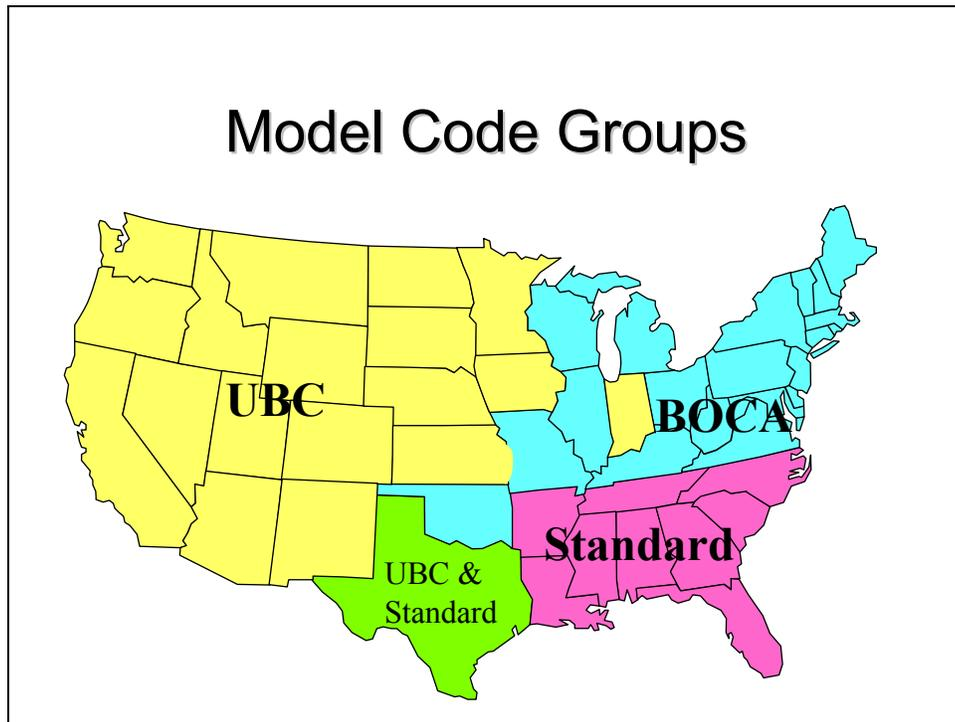

Slide A1.8

- ### Model Building Codes
- Used annual revision cycles
  - Revisions based on changing methods of construction and experience
  - Revisions developed through an open public process
  - New edition every three years

Slide A1.9

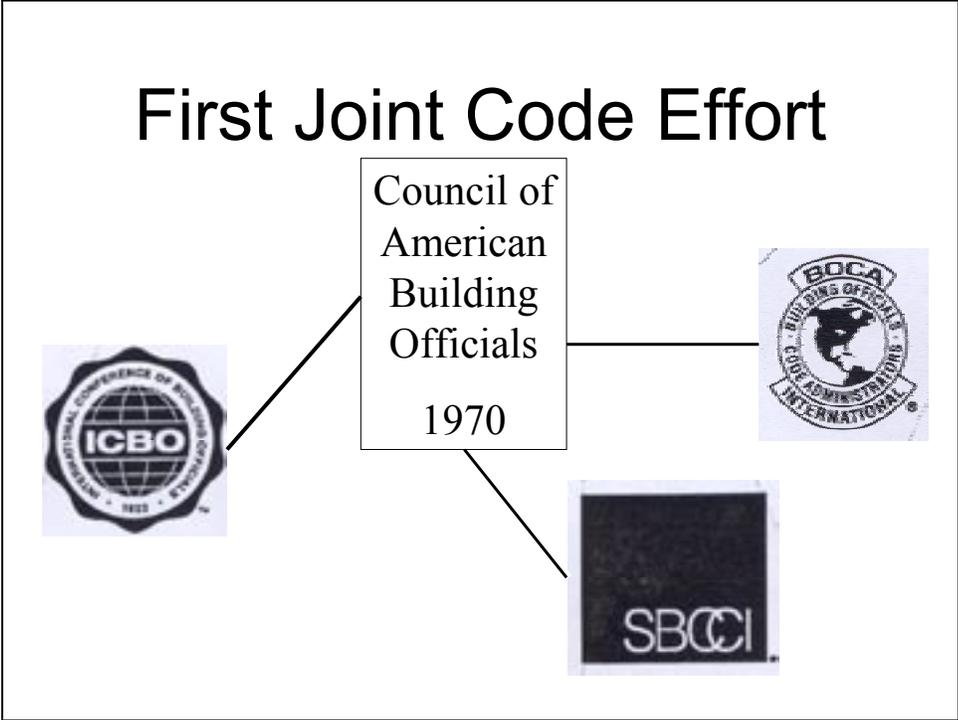

Slide A1.10

- ## CABO Model Codes
- One-and Two-Family Dwelling Code 1971 - 1995
  - Model Energy Code 1978 - 1995

Slide A.11

## Milestones for the Model Code Groups

- 1970 – formed CABO
- 1993 - ICBO and IAPMO dissolve partnership
- 1994 – formed International Code Council (ICC)

Slide A.12

## Milestones for the Model Code Groups

- 1994 - 1996 developed joint plumbing and mechanical codes
- 1997 – ICBO published last UBC
- 1998 – CABO folded into ICC
- 1999 - BOCA and SBCCI published last BNBC and SBC

Slide A1.13

## Milestones for the International Code Council

- 1997 - 2000 developed additional joint model codes
  - Building Code
  - Residential Code
  - Fire Code
  - Existing Building Code
  - Gas Code
  - Zoning Code

Slide A1.14

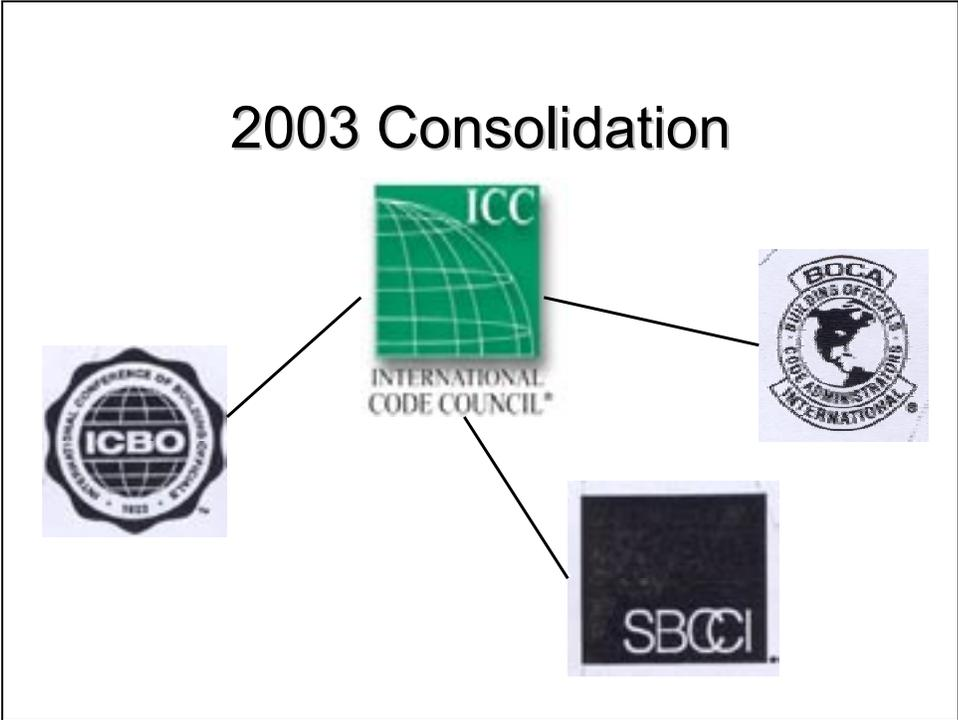

Slide A1.15



**A2.1 Implications of International Building on Design and Construction in Mississippi**

Dr. Harry Cole, PhD., P.E.

**Slide A2.1**

A couple a questions about the Louisiana legislation and Robert Varner was kind enough to send copies of this out yesterday and I sat up and read it last night. I said “my gosh it was written by lawyers.” Then I got up this morning and re-read it and it gave me a chance to mull through things. Prior to Katrina and the legislative session that followed, the state law simply said performance of enforcement procedures in connection to any building code shall be deemed discretionary. That’s lined out now, that’s gone. There is a statement in the preamble that is a little further down in the new material, that I think is applicable today in what we are talking about and why we are meeting here today, and you can substitute the word Mississippi for Louisiana in the following statement. “The public policy of Louisiana is to maintain reasonable standards of construction in buildings and other structures in the state consistent with the public health, safety and welfare of the citizens.” Ladies and gentleman that is why we are here today, that’s what this whole effort is about, the protection, the safety and the welfare of citizens of Mississippi. The act that goes on and on and on and on is to enable the state to promulgate, means to distribute with teeth in it, a state uniform construction code. This answers the question earlier, “Is it statewide? Yes, it is. We are going to talk about there is some implications to that and some possible sources of resistance for being statewide, and I think Louisiana makes a reasonable approach to address some of those issues. And finally to get on to a little bit here one thing that did not happen is that they only adopted those portions of the international building code that relate to building standards and safety. These were binding upon state and government agencies. What they didn’t do is that they already had a plumbing code and electrical code statewide, so the portions of the IBC that con icted with those were not adopted. You can see the reason why that would be important and will probably be resolved in the future as those two functions merge.

Well that puts us ahead of where we are Mississippi and I will say that Starkville has adopted IBC 2003 and from right outside Oktibbeha county there is absolutely no building code of any kind. Anybody can build anything. By the way I want to ask is there anyone from the Engineering Registration Board here today I know they were invited I was just wondering was there anyone here? Ok. As practicing architects and engineers we are very protective of our role in public service and public protection. We can’t let people offer their services as engineers or architects who are not trained and certified to design things for construction. That doesn’t prevent someone not claiming to be an architect or not claiming to be an engineer from building something and this is frightening. We have already heard today that Hancock County had no building code. So the presence of a building code is not a guarantee of good construction and a guarantee of suitability for the project, but at least it is a filter to try to keep the non-qualified people from building things that could affect the safety of construction.

## FINAL REVIEW

### Slide A2.2

What is the overall process of coming up with a design for building or structure? This is somewhat geared to the design professions but, generally speaking as a structural engineer, to design a structure to withstand the demand placed on it and demand is an all inclusive word meaning the forces applied to it during its utilization. We are here talking mostly about forces of nature, and specifically because of the recent events, we are talking almost exclusively about wind driven or hurricane driven events. So when I say loads it's generally what loads act on the structure. There is the weight of the structure itself called a dead load, the occupancy you and I we are called a live load, then there are the forces of nature and how do these combine. We have all sorts of models and these are addressed in the building code which tells how to combine the loads. Then we consider what are we making the structure out of timber, steel, concrete, and are there standard components, what sizes. Becoming very important are construction details. Many of the failures that we experienced with Katrina and many of the failures in both seismic events and other hurricanes are not primary members of the structure, but the secondary members, the construction details. To give you a very tragic example, the Hyatt Regency in Kansas City had a walkway collapse and killed a number of people about 15 or 20 years ago. That was a failure in the construction details. These are addressed in the building code and references to the code. Material properties. I want to take a minute to give Robert Varner an awful lot of credit for putting this thing together. He talked to me about it a month and a half ago and through his efforts this workshop has come together. I also want to give him credit, he represents a component of the material industries and up front his ground rules were we are not promoting anybody's product in this forum and we are not going to try to exclude anybody and we can't. To be fair to all people a building code is a performance standard and anyone whose materials can meet that performance standard in design and construction can play the game. So we talked about material properties and then the engineers put all this together in a suitable design model of some kind to come up with a predicted behavior of the structure so we can design the components to withstand the loads. That results in a design which many of you relate to as a set of plans and specifications that are then construction documents that the professional takes and builds an end product in the course of which there are quality control issues. Again I'm telling you a lot of things that most of you already know. A building code, and IBC is one of them, addresses all of these issues. Not just the effects of wind on the building, it addresses everything. We are going to get into a little more detail in a second on how it does that, but to put what I'm about to talk about in context I am going to talk about loading, what is nature demanding on our structure.

### Slide A2.3

We have heard the term today model building code and Steve did an excellent presentation of what a model building code is. It is a framework written by a code writing agency, in this case it the International Code Council. That brings into it by reference nationally accepted standards, and nationally accepted specifications and I use the terms differently and I am going to talk about each in just a minute. The International Code Council and its predecessors were not experts themselves in every aspect of every component of construction. So by reference national standards and national specifications

## FINAL REVIEW

are drawn into the building code. When a locality or a jurisdiction adopts the building code they are adopting the blue book that Steve showed you a minute ago and all of the references that are contained in that blue book. That represents the collective wealth of knowledge of this country in the construction process. Now state and local requirements, you have heard about Florida and some of the other states having specific requirements, then can become a local building code. The word local in the context that we are talking about would mean statewide. There are other building codes. I am involved in bridge design and AASHTO, American Association of State Highway and Transportation Officials, has a totally separate design specification and loading models for bridges, but we are not talking about bridges. Our friends at the Mississippi Department of Transportation are doing an excellent job I'm really proud of our state DOT. It is a professional organization that does a great job, but that's their issue, that's not what we are here to talk about.

### **Slide A2.4 - A2.5**

Now you heard earlier today about a model building code. A model building code is a framework, sort of a typically building code written by a private agency, the International Code Council is a private agency it is not a government agency and from the IBC 2000 it is to establish minimum requirements and the key word here is "minimum". As a structural engineer and all of you in the engineering and architectural profession know that when you are doing a design if you have reason to know that the conditions you are designing for are more stringent or demanding than minimum requirements obviously you take what you know. So that's the key word here. This word "minimum" was mentioned earlier and we want to emphasize that the adoption of the building code sets the minimum standard. The international code council does not have the power to police or enforce compliance. These must be legally adopted by duly-authorized governmental agencies. We have already heard that but it was worth hearing again. The current building code that appears to be the one most applicable to be used here in Mississippi is the International Building Code. I deliberately left off the date reference here because the current edition is the 2003 and the 2006 is almost ready to be released.

### **Slide A2.6**

I mentioned that a building code by reference pulls in specifications. The concrete industry has the American Concrete Institute and it is a national industry organization that represents the entire concrete industry in this country. They publish what is called ACI 318 "Building Code Requirements for Structural Concrete". The American Institute of Steel Construction is the national organization representing the steel producers and designers and they produce steel specifications. There are two current methods for design; the load and resistance factor design and separately allowable stress design. These have been merged into one, but I won't get into that detail. That's really not the point of this discussion. The point is these people here, American Concrete Institute, make up the concrete experts in this country. These people, American Institute of Steel Construction, make up the steel experts in this country and their publishing of these specifications is not all together altruistic exercise. Now these people compete with each other and so to better use their products they want to give the best and latest ground rules for you to make these

## FINAL REVIEW

products economically viable. Well who wins from all of this? The public wins. In the area of timber, timber is not as well organized because timber is a much more regional product than steel or concrete. There are several major players who have specifications from departments for timber construction and I won't read them all here, but these also are referenced in the International Building Code. Now I will say that as far as timber is concerned because it is a little more fragmented (that's kind of a bad word for timber) but because it is a little more fragmented than the steel industry or concrete industry the International Building Code on timber is much more prescriptive than steel or concrete.

### **Slide A2.7**

In the model code IBC one of the earliest sentences says "Structural concrete shall be designed and constructed in accordance with ACI 318 except as amended". You have got to remember the building code addresses not just the design aspects of using these materials, but the construction aspects, so what would not be appropriate in a design based specification is appropriate for inclusion in a building code. Both the concrete and the steel industries have put an awful lot of effort into designing for earthquakes. We are going to be using a term in a few minutes called N.E.H.R.P. It is a federally legislated and mandated National Earthquake Hazard Reduction Program. After the earthquakes in California in the early to mid 90's this country took off in developing earthquake research and improving earthquake design. Within the last year there has been a similar program established by congress the National Wind Hazard Reduction Program. We expect good things from that to work their way into our building code. There are similar national specifications and criteria for masonry and wood. These cover the major materials but of course there are many others for which there are other specifications, but my point is the International Building Code suddenly just geometrically expands its scope by reference to all of these documents. I tell my students in steel design that you learn the specifications for steel design because if you are building a building in a jurisdiction that has a building code that references the steel specification or the concrete specification, or timber specification those are legally binding. My point for dwelling on this is that the International Building Code represents the state of art in structural knowledge so what better model to use.

### **Slide A2.8**

Now design standards as opposed to specifications are a little more general and they apply to everybody. For example, wind loads on buildings. The American Society of Civil Engineers and I am a member and representative of them, has taken on the responsibility for collecting and publishing in one source design load requirements for building and other structures. Prior to their taking this on in the mid 90's every one of those specifications could find the kind of loads that we use to design buildings for, wind loads, seismic loads and things like that drawing from a number of different sources. The ASCE 7 is now the national standard for design loads. How does this pertain to what we are talking about in adopting the IBC? If you look at the current edition of ASCE 7 which just came out, I got my copy about 2 weeks ago. It's the 2005 version. The 2002 version is reference in IBC 2003. If you take a look at the wind loads portion, it is almost replicated here, there are some exceptions but it's almost word for word. What we are

## FINAL REVIEW

going to see here in a minute is that definitions placed on our buildings come from a nationally recognized source. Everything we have talked about so far is wind. Everybody is here because of the effects of Katrina. We are going to see in a minute that there is a potential hazard setting off in the corner of northwest Mississippi that could, I'm not an alarmist so please don't take it that way, that could pose a threat to the state equal to that Katrina already brought to us and that is earthquake.

### Slide A2.9

I mentioned earlier that the National Earthquake Hazard Reduction Program draws on many resources sponsored by the federal government, FEMA. Through the NEHRP program ASCE Edition 7 has brought in the definition of seismic loads. If you look at the ASCE 7 the 2002 edition it is almost word for word out of an earlier FEMA document in FEMA 358/359. The 2005 edition of ASCE 7 is much broader whereas, 3 years ago seismic zones were covered in one chapter of ASCE 7 now occupy seven chapters. American Institute for Steel Construction for example has seismic design of buildings. All of these have worked their way by reference into the International Building Code. So again Mississippi is very blessed and I'm using the term blessed with a much baited breath with demands placed on it by nature that very few other states have the privilege of experiencing. We talked about Florida and their hurricanes that's fine, but when is the last time you heard about an earthquake in Florida? California has earthquakes all the time, so when is the last time they had a hurricane? Mississippi, we have it all. We are the poster child for natural hazards and for that reason IBC is a good remedy for that.

### Slide A2.10

Now, I want to spend a little time talking about some of the forces of nature that are addressed in IBC 2003 Fig 1609 and ASCE 7. Any wind design done by engineers or architects starts with determining what wind speed are we going to design for and these profiles represent within the state the design wind speed. It was mentioned earlier that the southern coast of Mississippi has wind speed demands that equal that of the southern tip of Florida. Notice down here that 150 mile per hour wind profile that's the highest level on this map nationwide. For the design professional, it was mentioned earlier of going from the older southern standard building code. The definition of wind speed in those old specifications is different from the current definition. This is for those design professionals and those of you who are not will appreciate the analogy. Older specifications used the concept of fastest mile wind to define what wind speeds are that you would see on a wind design map. What is the fastest mile wind? Let's say you pull over at a railroad crossing and a train one mile long passes in front of you and you turn on your stop watch when the engine passes you and turn it off when the caboose passes you. During the time the train is passing you it might speed up and slow down, it's not necessarily running at a constant speed. You don't care about that; the definition that you are concerned about is kind of like an average. When that engine passes me until the time the caboose passes I can take that time and work that into the length of the train and you can come up with the average speed of the train. Averages are great. If you stand with one foot in a fire and one foot in a bucket of ice on average your feet are fairly comfortable. Ok that is not the current definition of wind speed as reflected in this map.

## FINAL REVIEW

The current definition was written and referred to earlier as the three-second peak gust. If you take a plot of wind speed you got a little anemometer setting up here spinning and make a recording of it, well speed versus time take a little width three seconds wide and slide it across until you capture the highest average peak and that is the definition now for fastest wind. There is correlation between the two, but the point is if you were to use the old standard building code wind map and then take those wind speeds and put them into the models under the IBC 2003 you will get very very bogus results. You've got to use the same definition for both. This is part of the education process for the community. So let's take a look at those profiles for a minute. Anywhere north of this line is designed for the interior part of the country with a minimum design wind speed of 90 miles per hour based on peak 3 second gusts. Between here and here you could interpolate, so if you were designing a structure were the tip of the laser pointer is you could use 95 miles per hour. The higher the wind speed the higher the pressure that the wind exerts on the building. In most designs of buildings we don't do a dynamic analysis of the wind. We convert wind into the equivalent pressure pushing against the side of a building as if it were stationary or static load. As we get closer to the coast you see two things happening. The speed is getting greater and the contours are getting closer together. So right around this area here is critical. Keep in your mind's eye what these profiles look like.

### Slide A2.11

This was a record of wind speeds that were recorded and these are from wind measurement stations all over the state. I also want to make a comment on the previous slide. In land United States, 90 mile per hour wind speeds, there is plenty historical data on which to base those predictive wind speeds. Down on the coast where the contours are 140 and 150 miles per hour are not based on historical records they are based on computer models that predict what the wind speed would be if a certain hurricane act came along. But as far as design professionals are concerned, we don't need to distinguish between the two. The path of the hurricane came up right up through here (referring to the map). I was fortunate; in the Starkville area we experienced winds up to 95 miles per hour for a period of about 3 hours. We got off pretty lucky. It went mostly to our west. Actually the center line of the storm was this (referring to the map) so if we look at the center line of the storm right around here were measured speeds of 140 miles per hour. I don't know the origin of this map so I don't know if these were peak 3 second gusts or the absolute instantaneous peaks. They are not far apart, so it's close enough for government work to call them the same for today. So peak gust of 140 miles per hour right around this region here (referring to the map) and if you look at an imaginary contour line here and I just stepped my way up to here (referring to the map). These agree reasonably well with the profiles we saw on the previous page. What is the significance of that? How many of these counties in here have a building code such as IBC 2000 / 2003? I'm underwhelmed by the response, not many. What does that mean? That means that had there been a statewide code which said "thou shall use the wind speeds on the previous slide" I cannot say that a certain percentage more would have survived than did or by conforming to that building code would have reduced the destruction by some percentage. But, it just seems logical that had those contours on the previous page been used as a basis for wind design in this part of the state there is a significantly higher likely

## FINAL REVIEW

hood that many more structures would have survived.

What effects does wind have on a building? It has two. One is on what is called “main wind force resistance system” in other words the skeleton of the building. It’s that part that you don’t want to disintegrate or come apart because otherwise the building collapses. The peripheral of the building is referred to components and cladding. Those are the pieces that you don’t want peeling off and becoming missiles, or coming off and exposing the building to rain damage. On the back side of the building there is always suction caused by the wind that will start popping the windows out. As the storm passes through the wind starts hitting on that side pushing air into the building trying to in ate the building like a basketball. A rupture of the skin of the building, not just the metal; brick or wood skin but also windows can create significantly more design pressure for the building. We heard earlier that the International Building Code does have requirements for heavy wind areas for either closeable shutters or debris resistant glass. In terms of how that would relate to multistory building, if the building is multistory building, the first 50 feet above the ground must have shatter proof glass. We heard earlier that Florida in Dade and Broward counties have a very strong program of required certification and physical testing of the devices to be sure they can perform. So, all of these things are tied together. Suppose we had a building code in place. I personally feel that there would have been a significant but immeasurable reduction in damage. Maybe we would not have experienced roofs peeling off so badly, walls blowing out and subsequent collateral damage. That does not address what’s happening here along the coast where a multitude of natural forces were happening. Here in Hattiesburg I still see the trees down and buildings damaged and up as far north as Starkville we had wind related deaths as a result of falling trees. A statewide building code could have reduced some of the agony we experienced.

### **Slide A2.12**

It was mentioned earlier, this is anecdotal because I don’t have documentation to show this but I live right about here (referring to the map). Every spring bands of tornadoes come across this part of the state. In the International Building Code there are references to sources for designing to withstand the force of tornadoes. Would an ordinary homeowner go to that much expensive and trouble? They probably would not because the chances or your home being struck by a tornado are considerably less than you dieing in an airplane crash. Probability certainly plays a role. However, what happens when there is a tornado drill or tornado siren? In schools all the kids go into the halls. If you are outside you try to go into a building. If the building is a designated a shelter there are many things you can do to mitigate or hardened that building against the effect of a tornado. What is one of the primary sources of damage caused by tornadoes? It is objects being picked up and thrown into the side of buildings thus, breaking into the building or even causing it to collapse. There is a group at Texas A&M University which is the premiere leader in wind research. They have a very interesting device for testing wind driven debris. They have an air cannon that literally blows objects into the side of a wall. They have classified the three levels of objects. One is the size of a short 2x4. The next is the size of a big 6x6. The third object is a Volkswagen being blown against the side of a

## FINAL REVIEW

building. My point is even for the pressure reductions that occur when the tornado passes over the building, thus causing the pressure inside the building to suddenly be higher than on the outside causing the building to explode. There are ways of mitigating that and a statewide building code would help in schools and other areas where we look for sources of refuge where we can minimize that damage.

### Slide A2.13

I know that the topic of today was primarily Katrina related events, but I want to impress on us all that there are more than just hurricanes. I said earlier that we are the poster child for natural disasters. Floods are addressed in the IBC and the parent documentation ASCE 7 and there are two types of floods. One is river flooding. I live near the Tombigbee; fortunately I don't live in Columbus, Aberdeen and places along the river where every spring they experience floods. There is also the Pearl River and the Mississippi River that may experience flooding. The other type of flooding is coastal flooding due to storm surge. Those are separate issues that are both addressed in an ASCE report that is yet to be released on storm surging. When the state moves ahead with a building code which addresses the fact that certain areas of the state are subject to different hazards, that storm surge report is going to be very important. That reference document will help deciding what to do down in the coastal region. Both in the area of land use, what is to be permitted in certain areas, and whatever is built trying to insure its survivability.

### Slide A2.14

Another example of natural disasters is earthquakes. I was in California many years ago driving through LA when there was an earthquake, but I never felt it. The vibrations of the car matched the vibrations of the ground motion. Do you know that in March of 2003 there was an earthquake centered in Fort Payne Alabama which is in the upper northeast corner of the state of sufficient magnitude that it rang church bells and knocked things off shelves in Atlanta and as far west as the Mississippi River. It does happen around here sometimes. When you look at a code approach and the question is how we model the effects in order to come up with something. The approach to design for earthquakes is to first look at the use of the building. We do earthquakes a little differently than we do wind storms. When a hurricane passes over Biloxi hopefully as soon as it is gone that hospital will be able to re-open and start admitting patients who are casualties of the storm. In a wind design environment we design for survivability and continuation of functioning in essential structures. In seismic design it is a little bit different. You generally for most buildings design them simply not to collapse during an earthquake. They may be damaged so severely that they may have to be demolished afterwards, but as long as they don't collapse and kill the occupants then that building has done its job if what is called a maximum expectant earthquake were too occurred. The rate of return is once every 2500 year. But as you see in California just because they had a fairly high level earthquake several years ago doesn't mean we are set for the next 24999 years it doesn't work that way. It's probability. Most buildings in California are designed for about a 50 year reoccurrence of a certain earthquake. Only the buildings that are considered essential structures and should remain operational under small frequent earthquakes, or to be able

## FINAL REVIEW

to re-occupy after the design earthquake and these are hospitals that are built in San Francisco. San Francisco is one of the highest fault areas and the hospitals are the highest usage, so you put those two together that is kind of the standard for greatest expectation of survivability. Most buildings fall into other categories. Farm buildings it doesn't really matter if they reach near collapse. Apartments and office buildings are designed to at least remain life safe under the design earthquake so they don't collapse. The only reason I say this is because the expectations of a structures performance are different in earthquakes than they are in hurricanes. First thing you do when you design for an earthquake is look at what do I want that building to be able to do after the earthquake occurs? If I want it to remain operational I classify it as use group number III. That's the highest use group. Most buildings are a use group II. So that's one consideration.

### **Slide A2.15**

Another consideration when looking at earthquake performance is what kind of soils is the building sitting on? This has two ramifications. One is if its sitting on real soft soil and you can visualize some shaking is going to work its way to the ground, but also the soil profile underneath and then the epicenter of the earthquake determines the rate at which the earthquake shocks propagate. It is the shocking effect which causes buildings to be damaged by earthquakes. Soils are classified under their desirability. Class A, if you can put a structure on hard rock it's got a pretty good chance of surviving. Taking a look at these generalized profiles, what do we have in Mississippi? We have a lot of soft soil profiles or mixtures of stiff and soft profiles. You know the expansive clay. We are blessed in Mississippi with a high probability of a natural event of some kind and also some of the worst soils to build on. So soil classification has an impact on earthquakes.

### **Slide A2.16**

Finally, what is the expected ground motion? Take a look at this map. This is not done on historical records this is done by geologist on probability phenomenon. Here is good ole Mississippi and these contours represent ground motion acceleration. Right here is an area referred to as New Madrid Missouri. What do you know about New Madrid? What happened in 1812? There was a major earthquake that occurred in New Madrid of sufficient intensity that the Mississippi River was shocked to flow north for several hours and church bells in Philadelphia, Pennsylvania rang due to ground motions. Notice that Charleston, South Carolina is in a concentrically spiraling inward set of contours and they are in a high risk area for ground motion. In the eastern part of the United States the geology is different than in California. In California you can have a really severe earthquake which is going to immediately impact the immediate vicinity, but won't affect Oregon, Utah or Arizona. In the eastern part of the United States the geology is such that if another earthquake were to occur at New Madrid its going to be felt all over the entire eastern part of the United States to some degree.

### **Slide A2.17 - A2.18**

When you put all of this together those three bits of information and you come up with what we call a seismic design category A through F. Just like in school you do not want an F. Actually from seismic design, if your combination of usage, ground characteristics,

## FINAL REVIEW

and expected ground acceleration combined puts you at A, B, or C you are in pretty good shape. D is not good and E and F are definitely bad. A good portion of California is rated seismic design category D. California is the earthquake capital of the world.

### **Slide A2.19 - A2.20**

Putting all that together, if we were building a building in northern Mississippi on solid rock the seismic design category up here would be B, which is not real high. Category A is minimal we would not even worry about it. Those of you in the design profession and have done federal work since I think 2003 or 2004 there is a federal executive order mandating that all federal buildings be at least considered for earthquake affects. If you have a building in site class A or B generally speaking if you designed the building to withstand a wind storm it will most likely withstand an earthquake. How many sites in Mississippi are found on bedrock?

### **Slide A2.21**

So if we look at the next level this is stiff soil or stiff sand. We have a little bit of this, notice as we get to a little poorer soil conditions if we were building a building here or if we were up near Memphis we are suddenly in the seismic design category C. Now, what's the soil like in Memphis? Well, it depends on where you are.

### **Slide A2.22**

If we get into soil that is lesser quality that's getting into the stuff we have around this state quite a bit. Take a look here at site class D. If we are building a building in this corner of the state we would have to aggressively and proactively look at seismic design.

### **Slide A2.23**

If we go through site class E, soft clay, which there is an awful lot in the northern part of the state. Notice seismic design category D covers the upper two-thirds of the state and if we going to build a hospital in Jackson and it happened to be on really soft clay we could be in a situation where we've got a potential seismic hazard equal to that of California. My point is we can't just focus on what's happening on the coast. If we are going to adopt a building code we have to protect everybody in the state from whatever the biggest source of threat is. The International Building Code addresses all of this.

### **Slide A2.24**

We looked at wind loads experienced during Katrina they compared with the wind loads predicted by the International Building code. Fortunately, we can not make that comparison with earthquake design because we have no records in Mississippi for comparison and I hope we never do.

### **Slide A2.25**

If we look at the IBC 2003, the one that we are proposing as the starting point for the model code for the state, it covers most of the natural hazards that we can experience in the state. But by reference it goes back to the ASCE 7 which picks up all the rest of them like rain loads and ice loads. We are probably not going to have severe ice loads,

## FINAL REVIEW

but how about snow loads? About 8 or 9 years ago there was a snow storm in Tupelo and due to drifting on the roof of an industrial building the roof collapsed. So, yes we can occasionally have snow considerations. To varied degrees citizens of Mississippi are exposed to these risks in one form or another. The building code by being uniformly adopted throughout the state will help assure a structure that will protect the citizens from these risks.

### **Slide A2.26**

What are the implications of adopting a code? Well, I put land use in here although, that is probably not a legitimate consideration in a building code it is more of a planning and zoning issue, but land use will affect what type of structures are being built and what the structures will have to be designed for. The implications are on the criteria specifically the design demands placed by nature on our structures and criteria as far as material performance, quality control, inspection requirements and many other criteria. The design practices if we were going to build that hospital in northwest Mississippi we may have to consider special seismic design considerations. They require both design practices and component system performance. On the coast component system performance becomes things like certified windows that won't break during a storm with flying debris. Material specifications and quality control, all of this will be affected by an adopted building code. Is that bad? No, I don't think so at all because what are we trying to do? We are trying to protect the public.

### **Slide A2.27**

It is a "model" building code. There will have to be options for modifications and exemptions. Here is one of the points that I want to get across. How many of you here are county supervisors or an elected official? Your constituents may not want to hear that they are going to have to comply with a building code. But, if they are educated and know how they are applied they won't have quite as much opposition. The recent Louisiana law recognizes this. Quote "groups or industries that are exempted from the Louisiana building code including electrical power generation, wood product manufacturer, paper manufacturer, petroleum, coal, chemical, plastic and rubber manufacturer, primary metals, hazardous solids and waste land fields" and the list goes on. Now does that mean that they can get away free? No. If I were Chevron or Texaco a company like that and I started to build a refinery I am going to consider all of the aspects. I may not consider them to the same degree because if a portion of the refinery were damaged during a hurricane sure it would go out of production and have an economic impact. But how many of the general public is likely to get killed by that happening? One, these patron industries are self insured and willing to take higher risks than we should allow the general public to be exposed too. The exemptions and modifications we spoke earlier today about high wind zones on the coast there may be some modifications there. There may be by adopting certain things like we have heard earlier today several things on residential construction. We have representatives from the residential industry here today and we are glad they are here. If we have a separate building commission or anything like that the members should include representatives from all major constituents that would be affected by a code such as; the home builders,

## FINAL REVIEW

the heavy construction industry, design professionals, and state agencies like the Board of Health who is interested in sanitary requirements.

### **Slide A2.28**

Statewide building codes are going to impose requirements on portions of the state where no requirements currently exist. I can address this by using examples. Many of my co-workers live in the county and say, "I don't want the state telling me how to build my own house." Well how you build your house is going to affect your family the next time a storm comes along. A little bit of extra cost on the outset building the house to code standards is going to improve the odds of surviving. For example FEMA has a concept of "safe rooms" in houses where you have an area that is a little more survivable. The one way to open up resistance is to say alright you build your house up to code and code is a minimum standard. Most reputable builders already build to code. Our friends here from the Home Construction Industry represent the good guys. Like in any profession not everyone is a good guy. The imposition of a building code isn't going to really raise cost in that regard if a house is built properly to begin with. Secondly, in Louisiana the state Insurance Commissioner is now going to tell people in Louisiana that they can get a premium reduction to owners of properties whose properties are built in conformance with code. So there is an inducement right there on the front end plus the increase in survivability. We heard earlier that in Florida there was a reduction in damage claims after Florida adopted their building codes. We have already heard how other states do this, but a statewide building code is going to require an administrative structure starting at the state level. What committee in the Senate and the House will oversee what agency that will oversee the council? How are we going to structure that and how are we going to be structured down through the local levels? Louisiana said that there will be a council that will certify officials at the local level. What is the administrative structure? We are looking at a bill going in soon. What should it contain? Not necessarily at this level of detail what the building code will require, but it should set the structure into place and give the authority to take on this task. We are going to need extensive education at all levels to bring design professionals up to the current design standards. Education down to the level needed to certify the local building official. This will generate a need for initial and continuing education. We have got to convince the general public that building codes are for their welfare. If we could get the support of the public to help elected officials understand that people are willing to accept the perceived short term increase in cost if this increase will result in long-term benefits.

### **Slide A2.29**

We are going to need commitment from our state government to make it happen. It's not going to be painless, but I think if we can win over the opponent, rather than beat them down; we will be in a better position. Now, most of you are either in the construction industry or you are a design professional and you probably would not be here if you were not on board with this.

### **Slide A2.30**

Finally, building for a safer Mississippi is what we want to do. That is going to require awareness, preparation, and education.

Slide A2.1

**Implications of International Building Code On Design and Construction in Mississippi**

**Mississippi Building Code Workshop**  
Hattiesburg Lake Terrace Convention Center  
December 16, 2005

Harry A. Cole, PhD, PE  
Department of Civil Engineering  
Mississippi State University

Slide A2.2

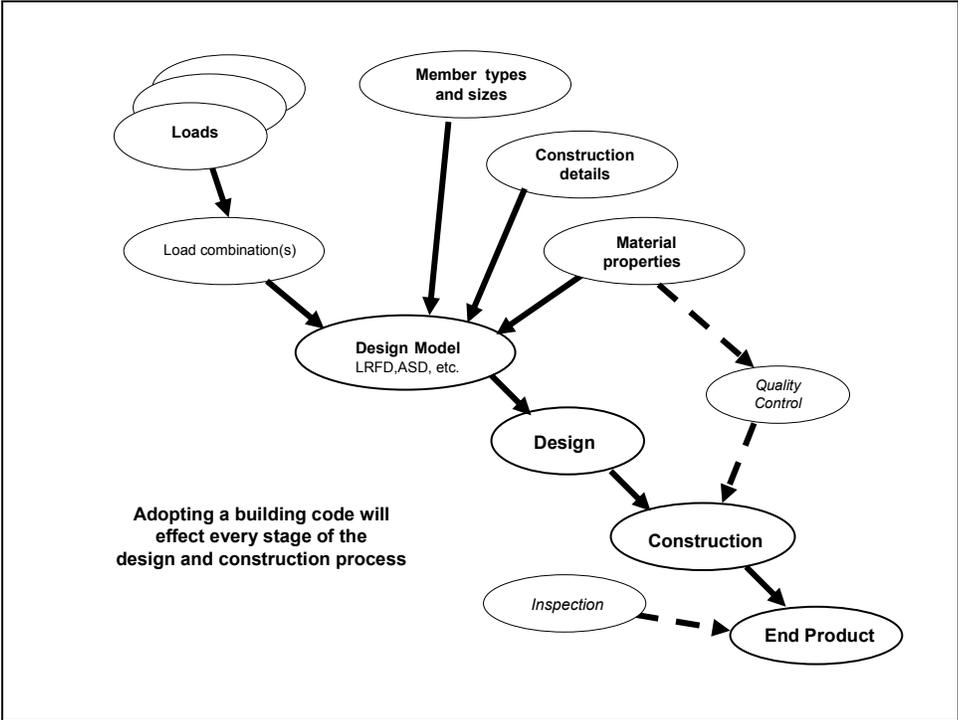

Slide A2.3

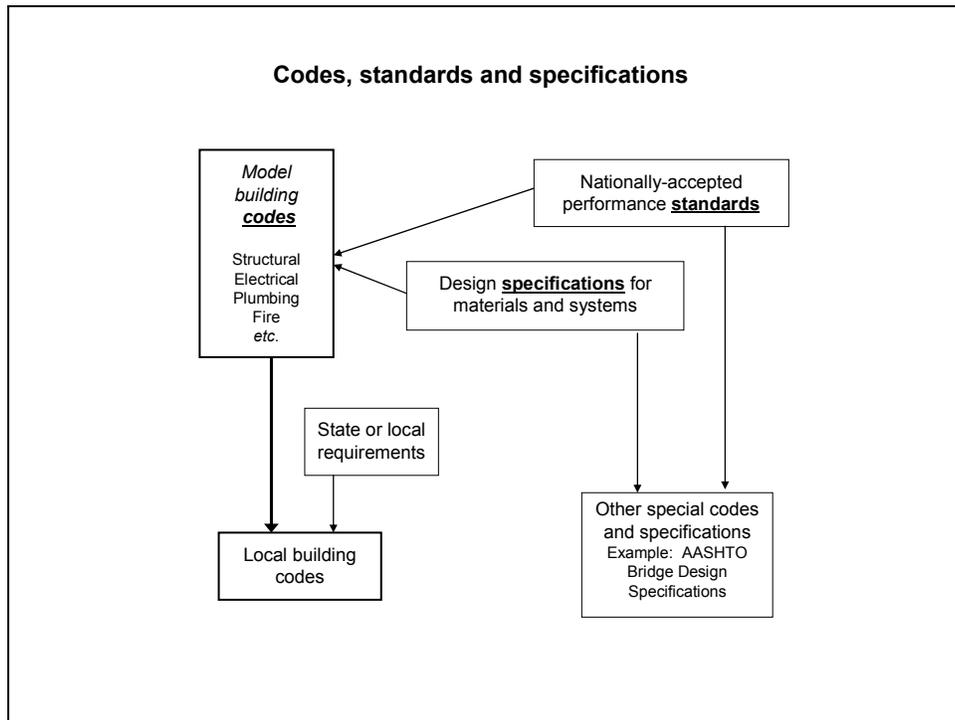

Slide A2.4

**Model Building Codes**

Prepared by private code-writing agencies:

1. Establish minimum requirements governing design, construction, maintenance and operation of property, buildings and other structures
2. The code-writing agencies ". . . do not have power or authority to police or enforce compliance with the contents of . . ." the code
3. Model codes must be legally adopted by duly-authorized governmental bodies ( cities, counties, states ) : "Only the governmental body that enacts the code into law has such authority"

Quotes from International Building Code, IBC 2000

Slide A2.5

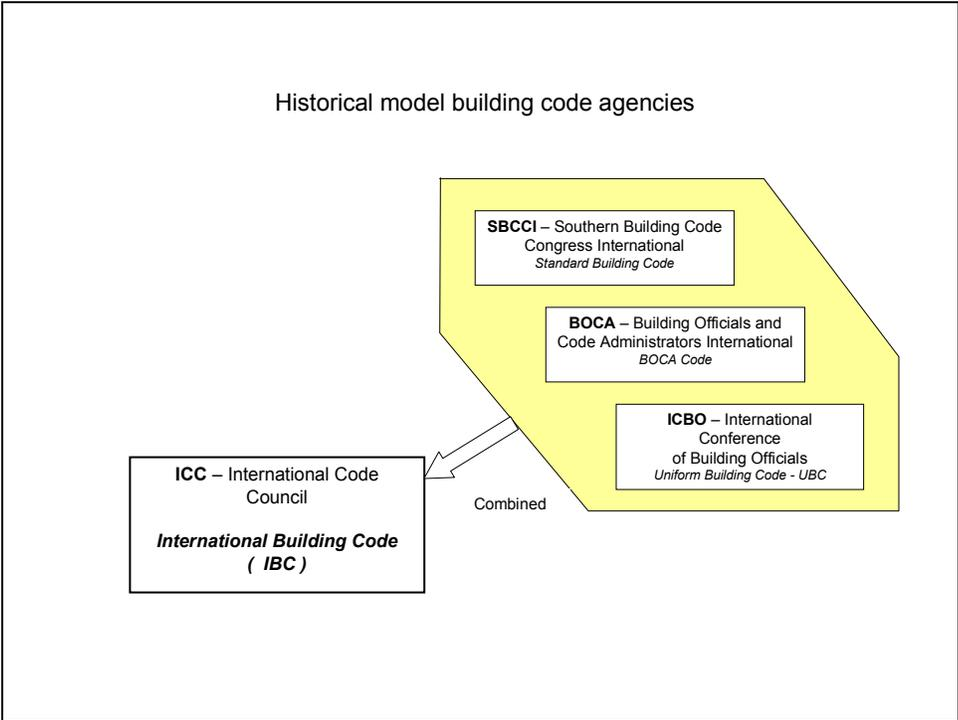

Slide A2.6

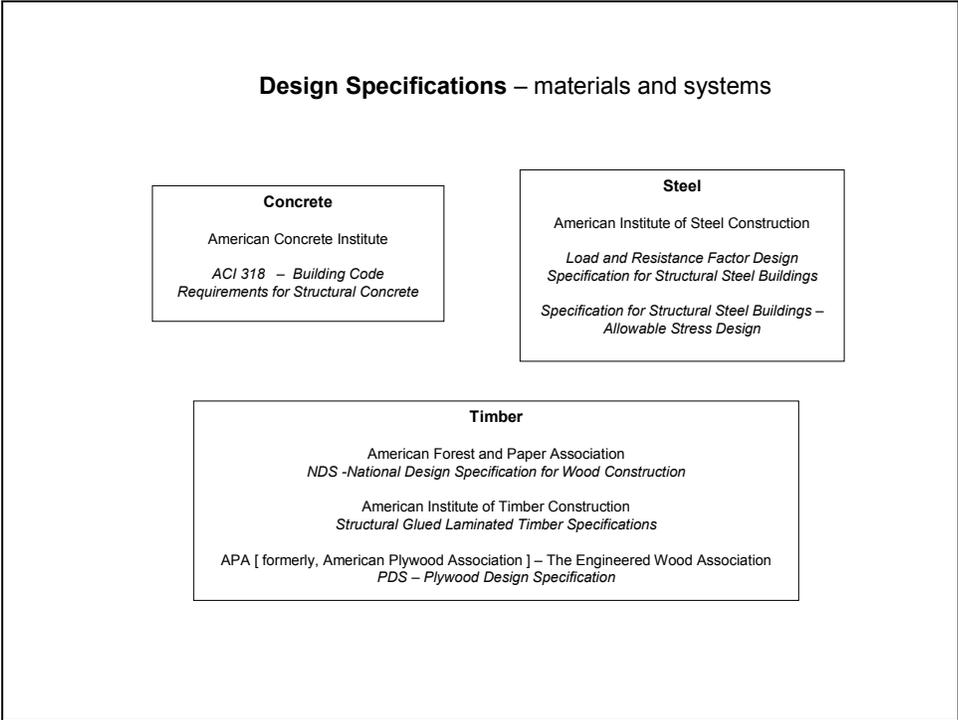

**Slide A2.7**

Model code: *IBC*

**Concrete**

Structural concrete shall be designed and constructed in accordance with the requirements of this chapter and *ACI 318* , as amended in .... this code

**Masonry**

Masonry construction shall comply with the requirements of this Section, and with those of *ACI 530.1 / ASCE 6 / TMS 602*

**Steel**

The design, fabrication and erection of structural steel for buildings and structures shall be in accordance with either the *AISC-LRFD*, *AISC 355* or *AISC HSS*.  
Seismic requirements – *AISC 341*

**Wood**

The provisions of the Chapter apply...( with references to *AFPA*, *AITC*, *APA*, and other agencies )

**Slide A2.8**

**Design Standards – General information ( such as load definitions )**

**Example 1: wind loads on buildings**

```
graph LR; ASCE["ASCE – American Society of Civil Engineers  
Minimum Design Loads for Buildings and Other Structures – ASCE 7"] --> ICC["ICC – International Code Council  
International Building Code (IBC)"]
```

Slide A2.9

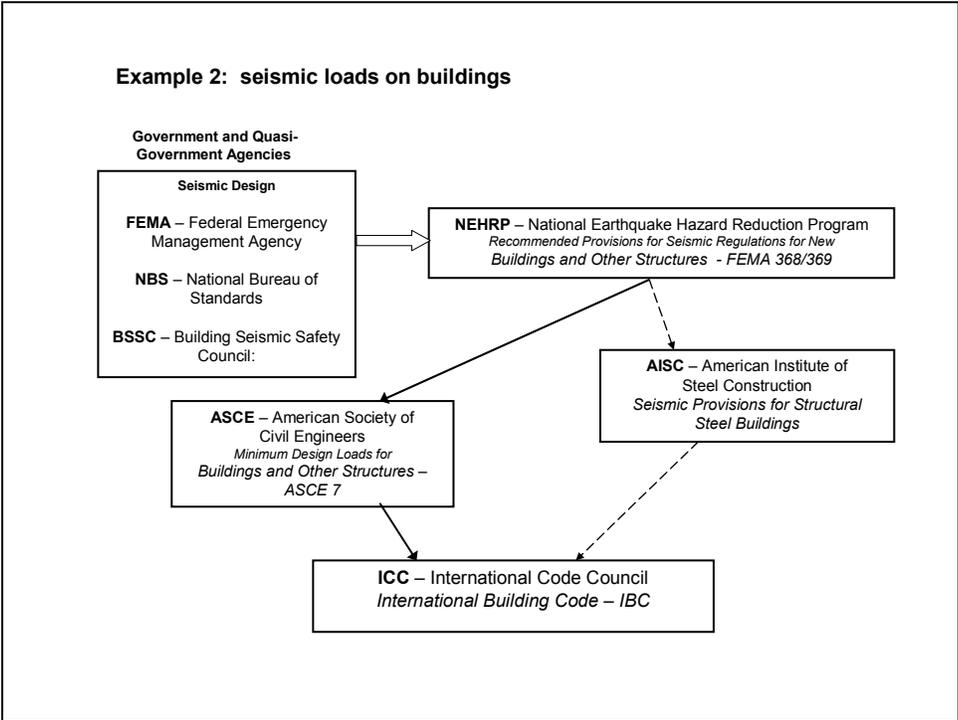

Slide A2.10

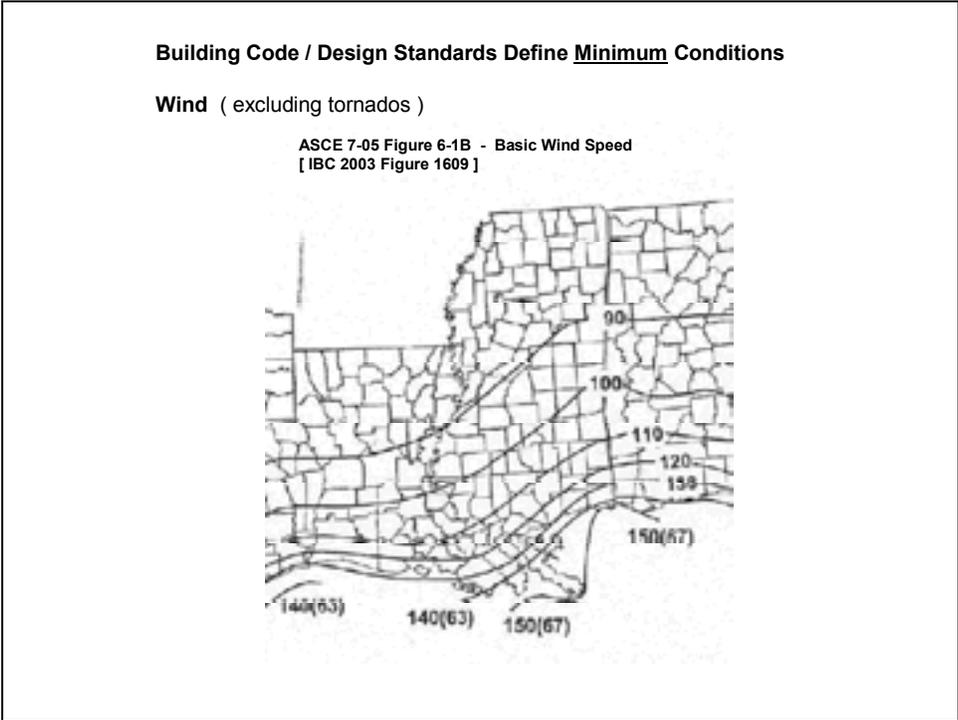

Slide A2.11

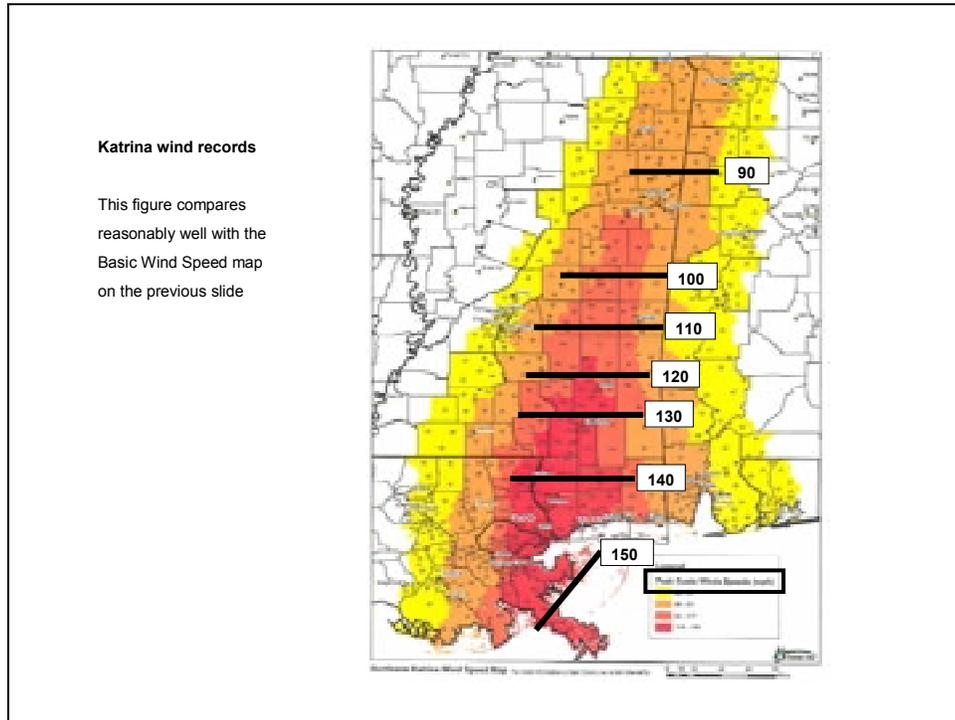

Slide A2.12

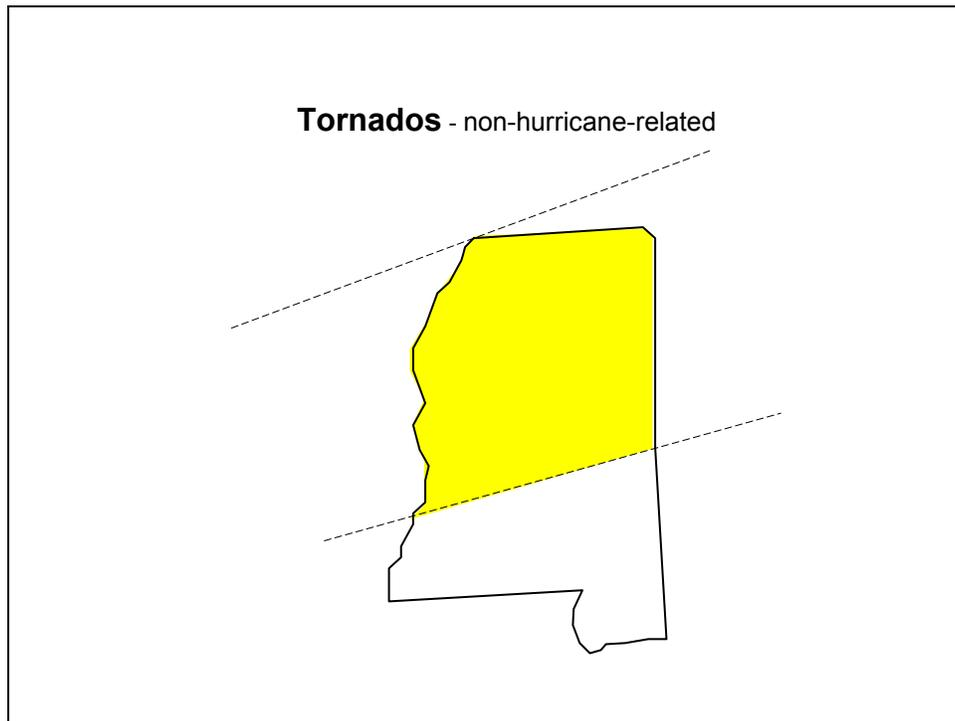

Slide A2.13

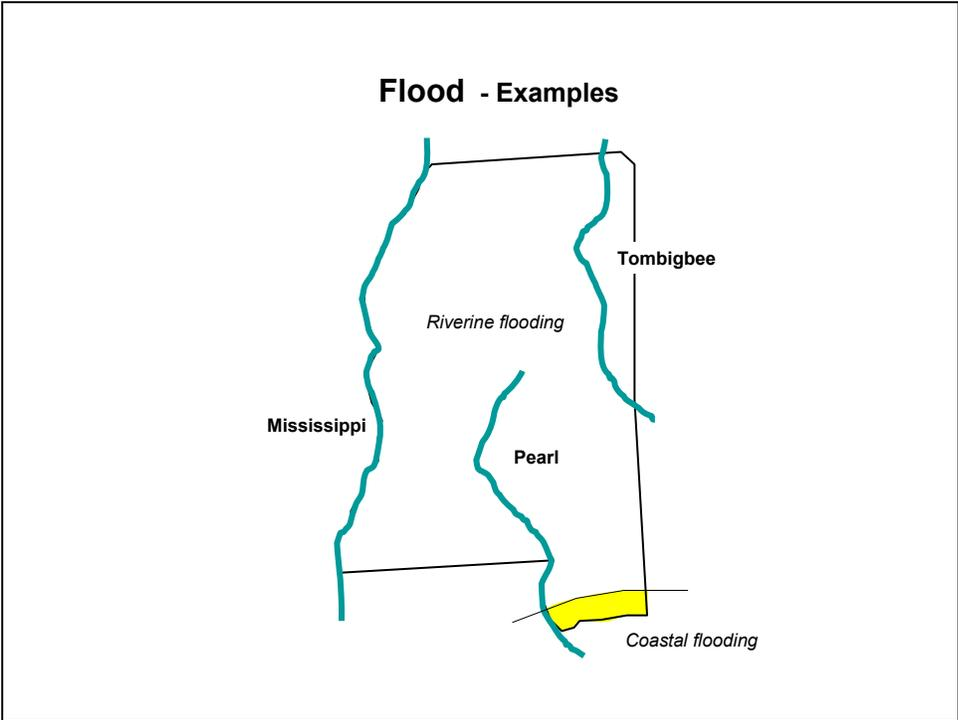

Slide A2.14

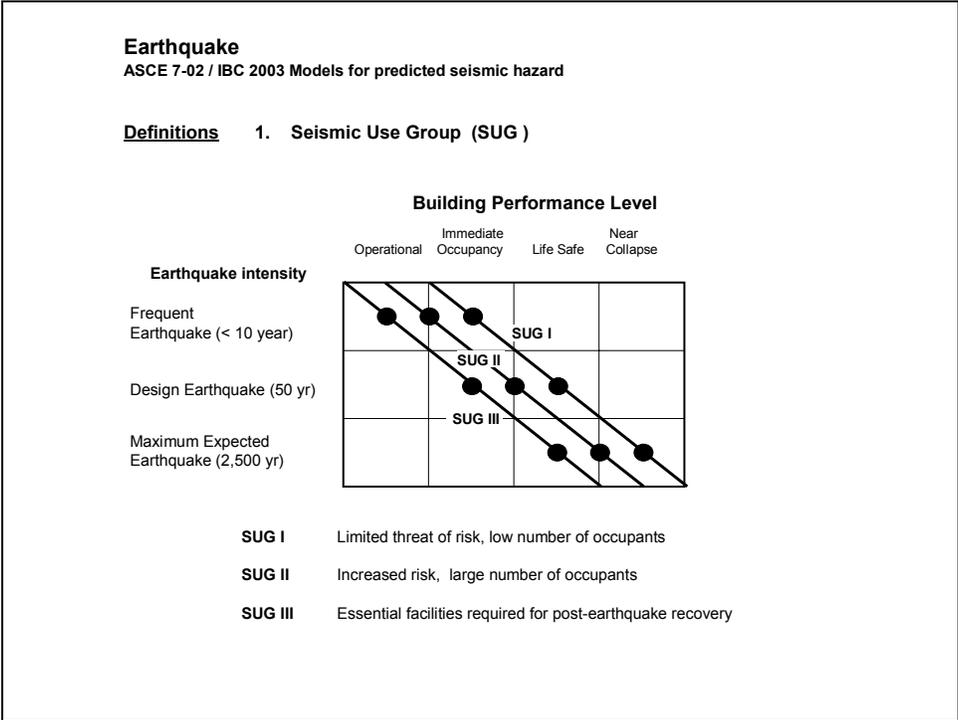

**Slide A2.15**

**2. Soil Classification ( "Site Class Definitions" )**

<b>Class</b>	<b>Soil Profile Name</b>
<b>A</b>	Hard rock
<b>B</b>	Rock
<b>C</b>	Very dense soil and hard rock
<b>D</b>	Stiff soil profiles
<b>E</b>	Soft soil profiles
<b>F</b>	Soils vulnerable to potential failure or collapse under seismic loading

**Slide A2.16**

**3. Ground motion acceleration maps:**

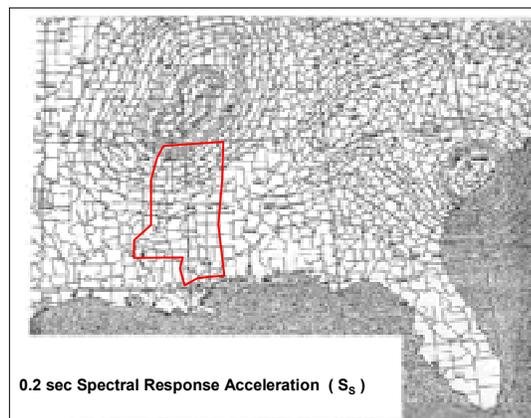

Slide A2.17

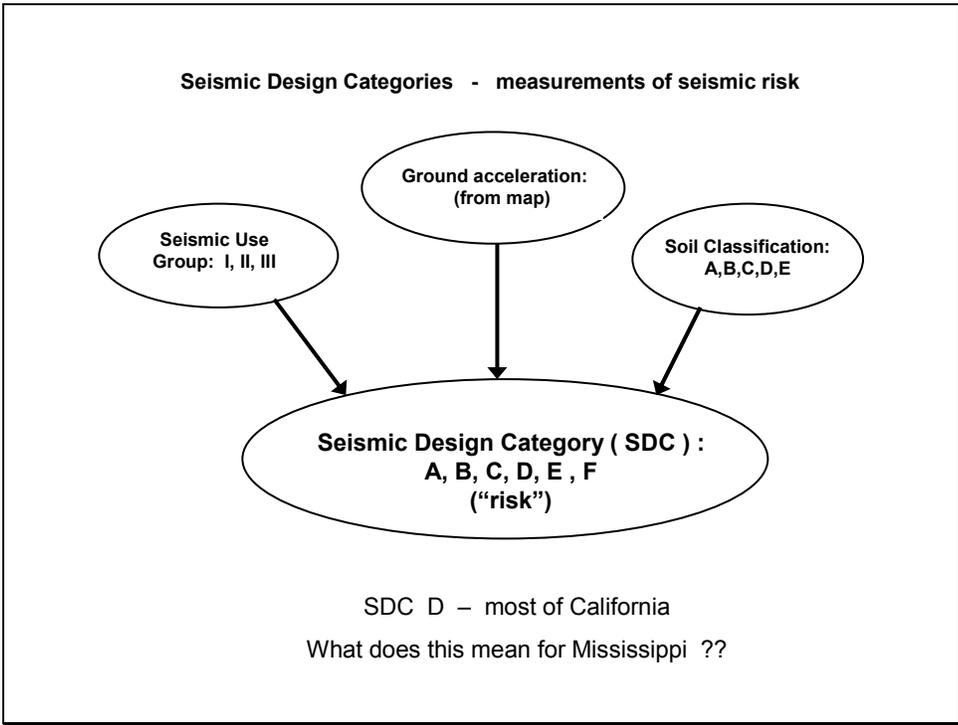

Slide A2.18

<b>SDC</b>	<b>Seismic risk conditions</b>
<b>A</b>	Earthquake ground motions small; wind generally controls design of lateral force resisting system
<b>B , C</b>	Group I and II structures in regions where more severe seismic activity is expected ( compare wind/earthquake demands )
<b>D</b>	<ol style="list-style-type: none"> <li>1. Group III structures in regions that would be SDC B,C for Group I and II structures</li> <li>2. Structures in regions expected to experience destructive ground shaking, but not near major faults</li> </ol>
<b>E</b>	Group I and II structures located close to major faults
<b>F</b>	Group III structures located close to major faults

In general, the higher ( A → F ) the SDC, the more severe the seismic design criteria. For steel structures ( as per AISC Seismic Design Manual ):

**SDC A , B , C**      "Special" seismic criteria are not mandated. Structures that satisfy wind criteria generally have adequate inherent seismic resistance ( i.e., ductility ). The primary requirement is that there be an adequate load path to ground for lateral loads ( wind, seismic )

**SDC D , E , F**      "Special" seismic provisions are mandated to provide strength and ductility, and to control drift.

Note that the SDC also may dictate the method of analysis that must be used. For all but the most severe cases, the "Equivalent Lateral Force" ( ELF ) method may be used.

Slide A2.19

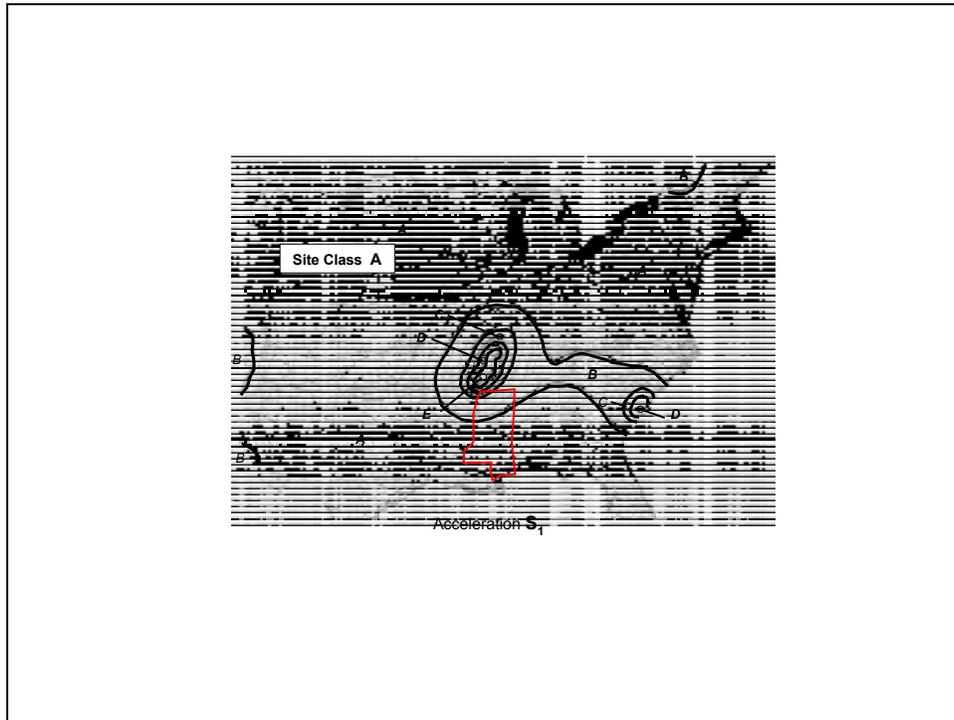

Slide A2.20

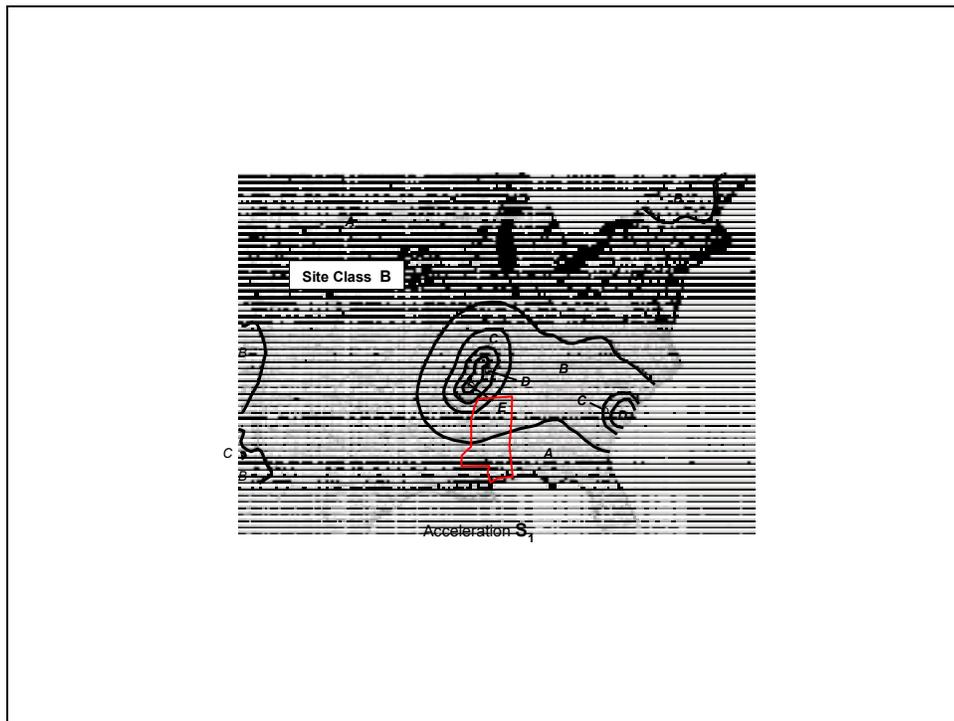

Slide A2.21

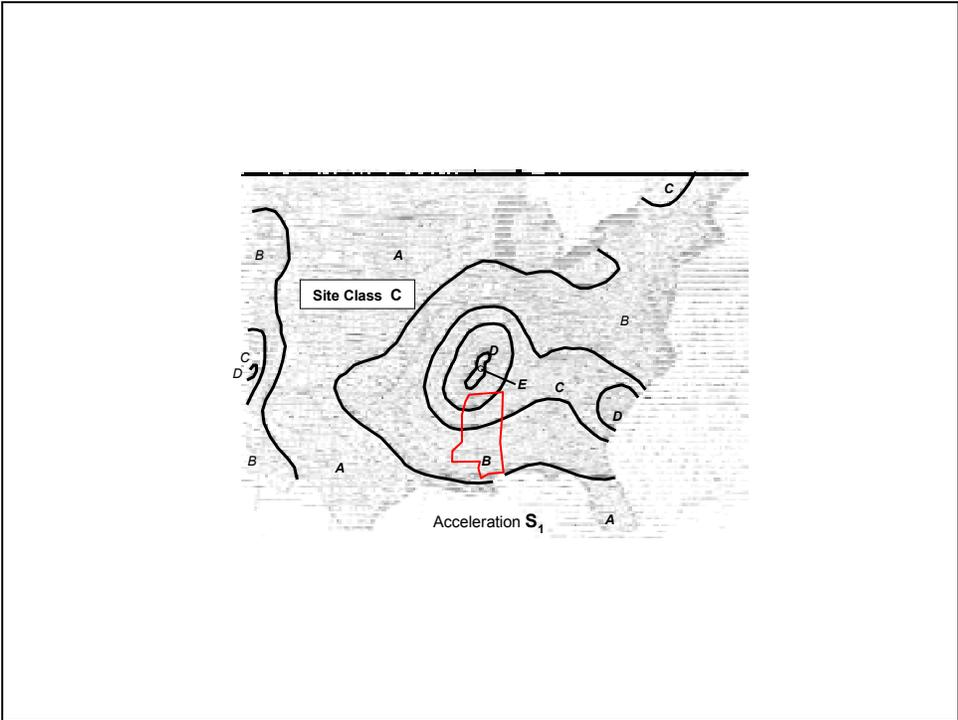

Slide A2.22

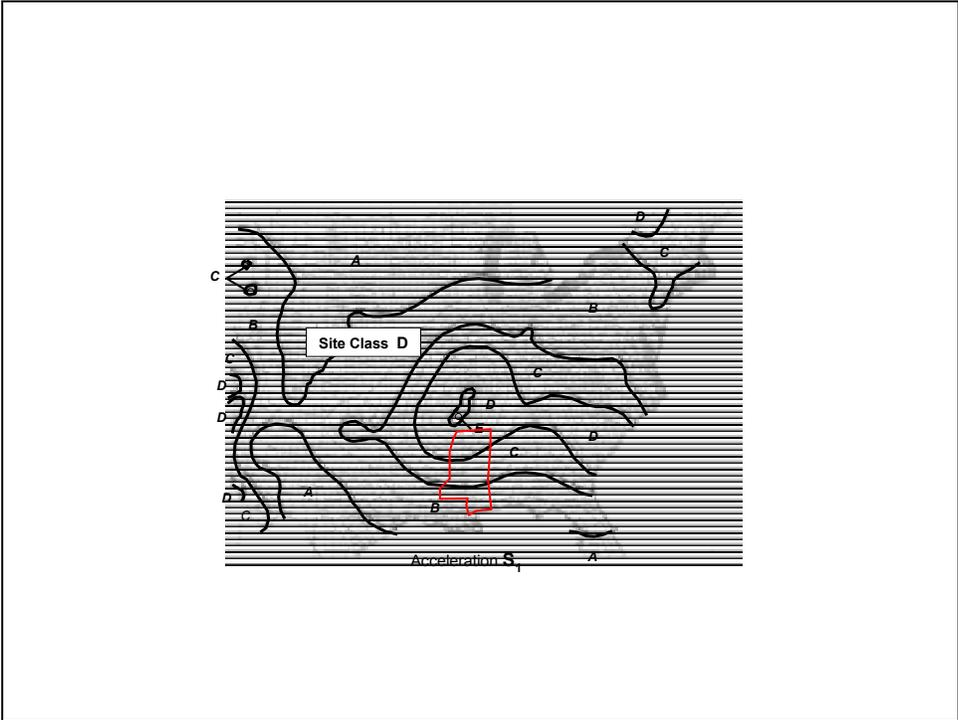

Slide A2.23

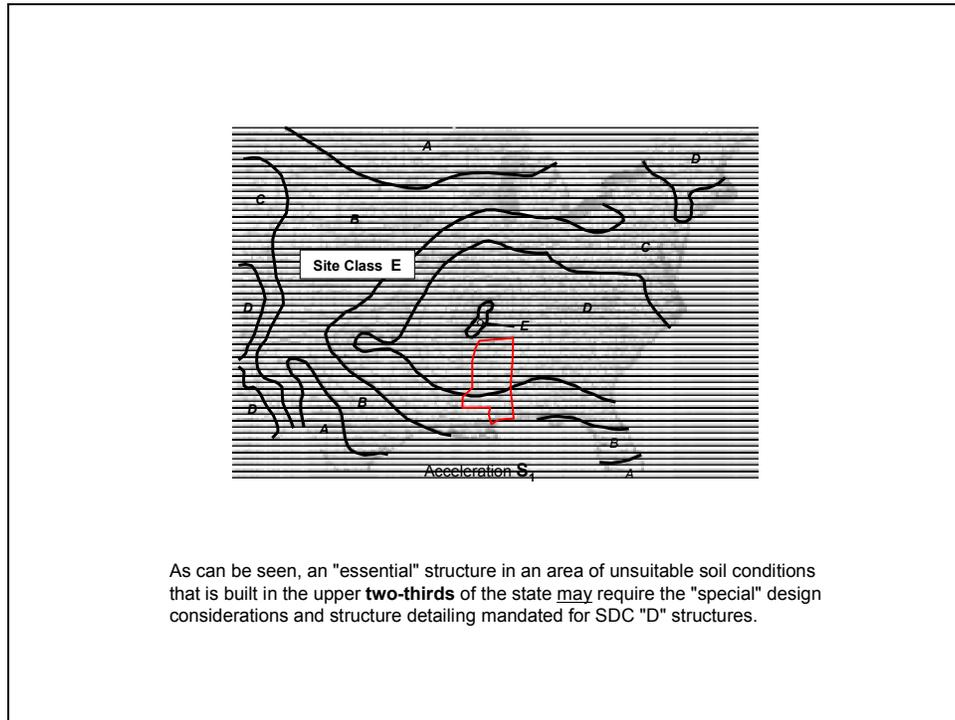

As can be seen, an "essential" structure in an area of unsuitable soil conditions that is built in the upper **two-thirds** of the state may require the "special" design considerations and structure detailing mandated for SDC "D" structures.

Slide A2. 24

**Fortunately, there are no actual earthquake records for comparison . . . . . yet**

**Slide A2.25**

Correlation of design load references: IBC 2003 and ASCE 7-05

	<b>IBC 2003</b> Chapter 16 – Structural Design	<b>ASCE 7-05</b> Chapters + Commentaries
Dead loads	Section 1606	Chapter 3
Live loads	Section 1607	Chapter 4
Snow loads	Section 1608	Chapter 7
Wind loads	Section 1609	Chapter 6
Soil lateral load	Section 1610	Chapter 3
Flood loads	Section 1611	Chapter 5
Earthquake loads	Section 1613-1623	Chapter 11 - 23
Rain loads		Chapter 8
Ice loads		Chapter 9
LOAD COMBINATIONS	Section 1605	Chapter 2

To varying degrees, all of the forces of nature listed above have an effect on the welfare and safety of citizens of Mississippi

**Slide A2. 26**

**Implications of adopting a statewide building code, such as the International Building Code**

- Land use**
- Criteria**
- Design practices**
- Component and system performance**
- Construction details**
- Material specification and quality control**
- Construction inspection**

**Slide A2.27**

IBC is a ***Model*** building code - the state will have  
the option for modifications and exemptions

**Slide A2.28**

**A statewide building code will impose requirements  
on portions of the state where no requirements currently  
exist - there will be resistance**

**A statewide building code will require an administrative  
structure in the state and local jurisdictions to set  
standards and enforce compliance**

**A statewide building code will require an extensive education  
for the design profession (engineers, architects) and the  
construction industry – this will generate a need for initial  
and continuing education at all levels**

**Slide A2. 29**

**The adoption of a statewide building code will provide for the health and welfare of the public**

**The adoption of a statewide building code will require**

- A commitment from the state government (governor, legislature)**
  - Acceptance by local governments**
  - Support of the construction industry**
  - Commitment by the design professions**
- A willingness of the people to see that the perceived increase in costs in construction will result in long-term benefit**

**Slide A2.30**

***Building for a safer Mississippi***

**AWARENESS, PREPARATION AND  
EDUCATION ARE THE KEYS**

**March 2006**  
**Technical Report CMRC 06-1**